

MAINTENANCE AND OPERATION INSTRUCTIONS | EN

PL / PLB SERIES

Planet Geared

GEAR UNIT WITH MOTORS / WITHOUT MOTORS

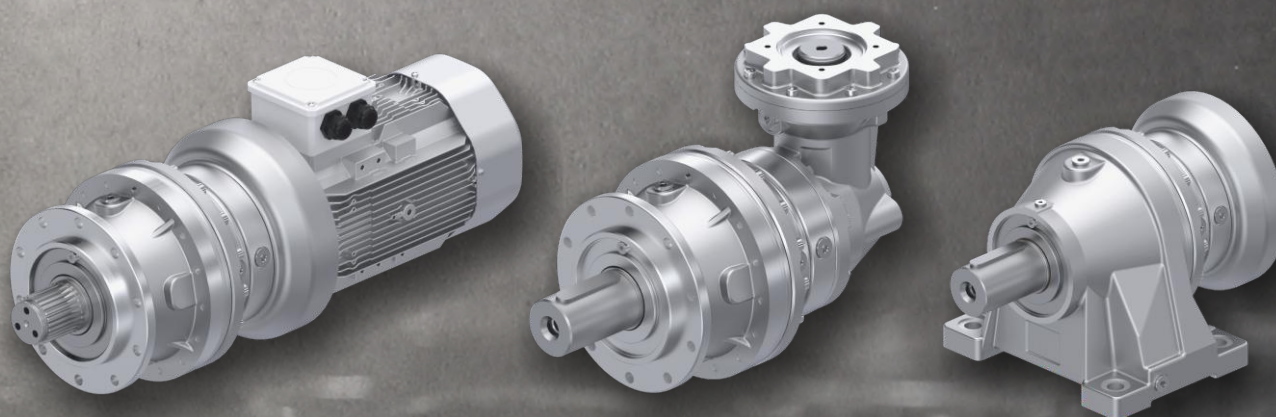

ATEX 

PGR[®]
DRIVE TECHNOLOGIES

Doc. No: PG.AG.KK.001_01

Rev. / Publication Date: 09.2021 / 04.2019

TSE K 558



Certificate No: KY3723/05/10-R15





The copyrights of the usage Maintenance instruction are belong to PGR company.

Usage guide could not be used partially or fully without our permission to the purpose of competition and not submitted to the use of third parties.

The right of changing informations which stated in the usage maintenance instruction partially or fully without giving any notice before or right of full changing and abolishment are kept reserved by us.



1. UNIT



GENERAL INFORMATION

1.1	Important Warnings	5
1.2	General Information	6
1.3	Correct Use	6
1.4	Safety Information	6 - 7
1.5	Responsibility	7
1.6	Transportation	7 - 20
1.6.1	Transportation and Freightage	7
1.6.2	Package Transportation	8
1.6.3	Equipment Transportation	8
1.6.4	Transport of Gearboxes	9 - 20
1.7	Storage	21
1.7.1	Long Term Storage Suggestions	22

2. UNIT



PRODUCT DESCRIPTION

2.1	Gear Unit Label	23
2.2	Compatibility Declaration	23
2.3	Explanations	24
2.3.1	Accessories	25
2.4	Abbreviations	26

3. UNIT



ASSEMBLY INSTRUCTIONS; PREPARATION, INSTALLATION

3.1	Prerequisites of Assembly	27 - 28
3.2	Gear Unit Mounting	28 - 29
3.3	Bolt Tightening Torque Value	29
3.4	Gear Unit Ventilation	30
3.5	The Mountage of the Connection Tool to the Output Shaft	30
3.6	Temperature Sticker	31
3.6.1	Visual Inspection of the Temperature Sticker	31
3.7	The Mountage of the Couplings	32
3.8	The Mountage of the Standard B5 Motor to the PAM Gear Unit	32
3.9	The Demountage of the Electrical Motor (PAM)	33
3.10	Gear Unit Operating	33







4. UNIT



CONTROL AND MAINTENANCE

4.1	Control and Periodic Maintenance	34 - 35
4.2	Visual Inspection	36
4.3	Check for Running Noises	36
4.4	Control of the Lubricant and Lubricant Level	36
4.5	Changing the Oil	36 - 37
4.6	Oil Plugs Squeezing Torc Chart	37
4.7	Change of the Ventilation Plug	37
4.8	Change of the Oil Seal and Oil Cover	37
4.9	The Bearing Greases	37
4.10	General Overhaul	38
4.11	The Maintenance of the Motor	38
4.12	Temperature Measurement	38 - 39



5. UNIT		MOUNTING POSITIONS	
5.1		Mounting Positions	40 - 44
6. UNIT		LUBRICATION	
6.1		Lubrication	45
6.2		Lubricant Fill Quantities	45 - 54
6.3		Lubrication Table	55
6.4		Expansion Tank	56
7. UNIT		ACCESSORIES	
7.1		Shrink Disc	57
7.1.1		Mounting Position of the Shrink Disc	57
7.1.2		Demounting Position of the Shrink Disc	58
7.1.3		Cleaning of the Shrink Disc	58
7.2		Torque Arm	58
7.3		Backstop	59
7.4		Input Accessories	59
8. UNIT		TROUBLESHOOTING	
8.1		Product Disposal	60
8.1.1		Disposal	60
8.2		Troubleshooting	61 - 64
9. UNIT		AUTHORIZED SERVICE	
9.1		Authorized Service	65
10. UNIT		WARRANTY	
10.1		Declaration of Conformity	66
10.2		ATEX Document	67
11. UNIT		CONTACT INFORMATION	
11.1		Contact Information	68



List of illustrations

Figure 1 : Transport of Gearboxes	9 - 20
Figure 2 : Gearbox Nameplate and Explanation	23
Figure 3 : Activation of Vent Plug	30
Figure 4 : The Mountage of the Connection Tool to the Output Shaft	30
Figure 5 : Temperature Sticker 1	31
Figure 6 : The Mountage of the Coupling	32
Figure 7 : The Mountage of the Standard B5 Motor to the PAM Gear Unit	32
Figure 8 : The Demountage of the Electrical Motor (PAM)	33
Figure 9 : Temperature Sticker 2	39
Figure 10: Mounting Positions	40 - 44
Figure 11: Expansion Tank	56
Figure 12: Shrink Disc	57
Figure 13: Torque Arm	58
Figure 14: Input Accessories	59





**List of tables**

Table 1 : Safety Alerts and Information Signs	5
Table 2 : Product Description (Explanations)	24
Table 3 : Product Description (Accessories)	25
Table 4 : Abbreviations	26
Table 5 : Bolt Tightening Moments	29
Table 6 : Control and Periodic Maintenance Ranges - Works	35
Table 7 : Oil Plugs Squeezing Torc Chart	37
Table 8 : Additional Oil Table	45
Table 9 : Lubricant Fill Quantities (PL - M / P / F / FS)	46
Table 10: Lubricant Fill Quantities (PL - M / F / FS)	47
Table 11: Lubricant Fill Quantities (PL - CPC)	48
Table 12: Lubricant Fill Quantities (PLB - M)	49
Table 13: Lubricant Fill Quantities (PLB - P)	50
Table 14: Lubricant Fill Quantities (PLB - F)	51
Table 15: Lubricant Fill Quantities (PLB - FS)	52
Table 16: Lubricant Fill Quantities (PLB - CPC)	53
Table 17: Lubricant Fill Quantities (PLB - CPC)	54
Table 18: Lubrication Table	55
Table 19: Lubrication Schedule While Cleaning of Shrink Disc	58
Table 20: Disposal Table	60
Table 21: Troubleshooting	61 - 64
Table 22: Authorized Service	65

1.1 Important Warnings



Take into consideration the listed safety warnings and information signs below!

Table 1: Safety Alerts and Information Signs

	EXPLOSION ! Indicates an immediate danger, which may result in death or serious injury. Contains important information regarding explosion protection.
	ATTENTION ! Dangerous position and possible result Slight and unimportant woundings
	NOTE ! Advices and necessary informations for the user
	DANGER ! Harmful position and possible result Damage in gear unit and environment
	DANGER OF ELECTRICITY ! Danger of electrical shock and possible result Death and heavy woundings
	DANGER ! Danger possible result Death and heavy woundings

1.2 General Information

This user guide is prepared by our firm to provide information about safety transportation of gear unit/gear unit with motors, storage, installation/mounting, connection, operating, maintenance and repair processes. All the purchase and technical data are positioned at product catalogues. Beside engineering applications, the information which is placed in this instruction, should be well read and applied. The documents must be protected and to get ready for controlling by authorized person. The information about electrical motor could be found by guidance which is prepared by motor-producing firm.

EXPLOSION !	
	<p>All the information those boxes include would only state proper goods to the instruction of ATEX 2014/34/EU.</p> <p>Processes which related to these regulations should only be made by personnel (qualified) who has expertise regarding security in the fields that has the probability of being exploded.</p>
	

1.3 Correct Use

PGR The products are designed to use in commercial plants and are operated convenient to the current standards and directions. Technical data and allowed usage conditions are placed in product's power tab and usage guidance. Should be conformed to all the values.

Gearboxes are designed proper to the security necessities of machine instruction 2006/42/AT. In all systems where these goods formed, we highly advice of to take 2006/42/AT machine instruction into a consideration. Engine(motor) suitability are in the responsibility of manufacturing company.

1.4 Safety Information

In gear units /gear units with motors and motors, there could be pieces subjected to voltage, movable pieces and hot areas. During all the works to be done; transportation, storage, placing, mounting, connection, operating, maintenance-repair processes could be implemented by qualified employees and responsible managers.

All the processes to be implemented during the working period;

- Related usage and maintenance instructions,
- Warning and Safety Tags in gear unit/gear unit with motor,
- Instructions and Requirements related to the system,
- Local and International requirements for safety and accidental protection,
- Disassembly of gearbox should only be made by authorized personnels.

Our Firm is not responsible where the listed items are implemented below:

- Violation of work health and safety rules in gear unit /gear unit with motors,
- Improper usage (The usage which stated out of bounds in guidance and all the usages except tag/catalogue values especially usage in high moment and different cycle) and mismounting and misuse of gear unit/gear unit with motor in plant,
- Extremely dirty and maintenance free of gear unit/gear unit with motor,

- Unlubricated usage,
- Usage of product other than out of tag/catalogue values,
- Wrong motor selection,
- Take out of the necessary protective plugs,
- Disuse of original pieces in gear unit/gear unit with motor,
- The using, mounting, maintaining and taking place of the uneducated, unauthorized and unqualified 3. persons,
- Additional dangers that could be generated during power cut can be prevented by materials such as brake/key.

1.5 Responsibility

PGR, declines any responsibility in case of:

- Use of the reducer not compliant with national laws on safety and accident prevention,
- Work done by unqualified personnel,
- Incorrect installation,
- Tampering with the product,
- Incorrect or failure to follow the instructions in the manual,
- Incorrect or failure to follow the indications marked on the identification labels fixed on the units,
- For motor gearboxes, wrong delivery of electrical power,
- Incorrect connections and/or use of temperature sensors (when present),
- Use of gearbox under unlubricated conditions,
- The contents of this manual were reviewed to ensure consistency with the catalogues and etc. documents. We cannot guarantee full consistency since the changes cannot be completely prevented. However, the informations in this manual are reviewed regularly and necessary revisions are made in next editions.

The products supplied by PGR are intended to be incorporated into "complete machines", so it is prohibited to put them into service until the entire machine has not been declared compliant.



ATTENTION !

The configurations provided in the catalogue of the unit are the only ones allowed. Do not use the product in contrast with the indications provided in it. The instructions provided in this manual do not replace but compensate the obligations of current laws concerning safety regulations.

1.6 Transportation

1.6.1 Transportation and Freightage;

- Take into consideration of the article stated on package during the product delivery.
- During the delivery, product should be controlled about possible damages in carrying period.
- The firm should be informed about possible damages.
- The damaged products should not be put into use.
- Lifting flanged eyebolts must be tightened. These flanged eyebolts sized to carry the weight of only gear unit/gear unit with motor. The additional weight should not be added. The flanged eyebolts must be suitable to the DIN 580 norm.
- If there are 2 lifting flanged eyebolts in gear unit with motor, both of them could be used in carrying process upon the size of gear unit and motor. In necessary situations, the suitable and adequate-size carrier should be used.
- Carrying safeties should be removed before the start of operating.
- The weights of the movable gear units/gear units with motors are placed in product catalogues.
- The dangerous area should be got into the secure to prevent damage to the persons.
- During the carrying process, to stand under the gear unit could cause danger of death.
- The damage of gear unit must be prevented. The crushes to the free input shafts could damaged into the gear unit.

1.6.2 Package Transportation;

- There could be no loads on packages or the shelved surfaces should be prepared.
- The necessary carrying equipments should be prepared.
- The carrying and lifting equipments should be larged - enough to the sufficient capacity.
- The calculations should be made to the connection points and center of gravity.
- If necessary, this information should be written on the package.
- The carrying equipments (steel rope, belt, chain etc.) must be robust and suitable to the applied weight.
- During the carrying process, the load centering could be done without oscillation.

1.6.3 Equipment Transportation;

- The connection carrying point should be appointed.
- The carrying equipments (hook, chain, belt) must be prepared. To the alternative, pallet must be used for the load - lifting.
- If the Crane will be used, it could be lifted perpendicular from inside to the outside of the package.
- If the forklift or palletized carrying equipment will be used, the product which removed from package should be placed on the pallet.
- The fork of the equipment should be carried out the way that gripped the pallet.
- The weight must be lifted both with slowly and constant speed and must take measure to the sudden oscillation.

**ATTENTION !**

During the carrying process, the fixings like the lifting lug, hook, belt, rope, locked hook must be sufficient to the load and have conformity certificate. The weights of the movable gear unit/gear unit with motor have given in product catalogue.

**NOTE !**

In all carrying processes, there should be avoided from both sudden movements and sudden liftings.

**ATTENTION !**

If the connection tool is coupling between electric motor and gear unit, lifting eyebolt should not be used.

1.6.4 Transport of Gearboxes;

Figure 1: Transport of Gearboxes

PL - MS

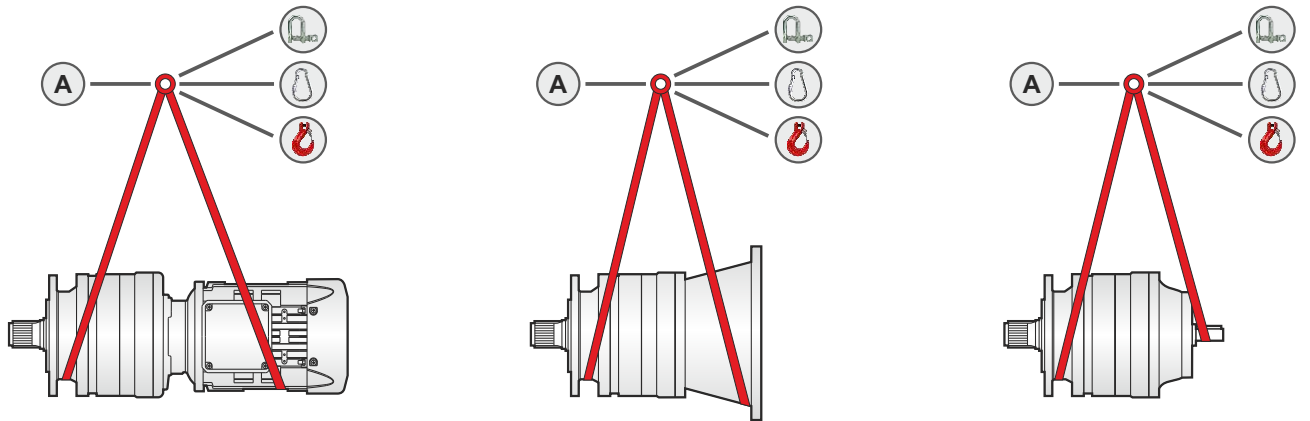

PL - MC

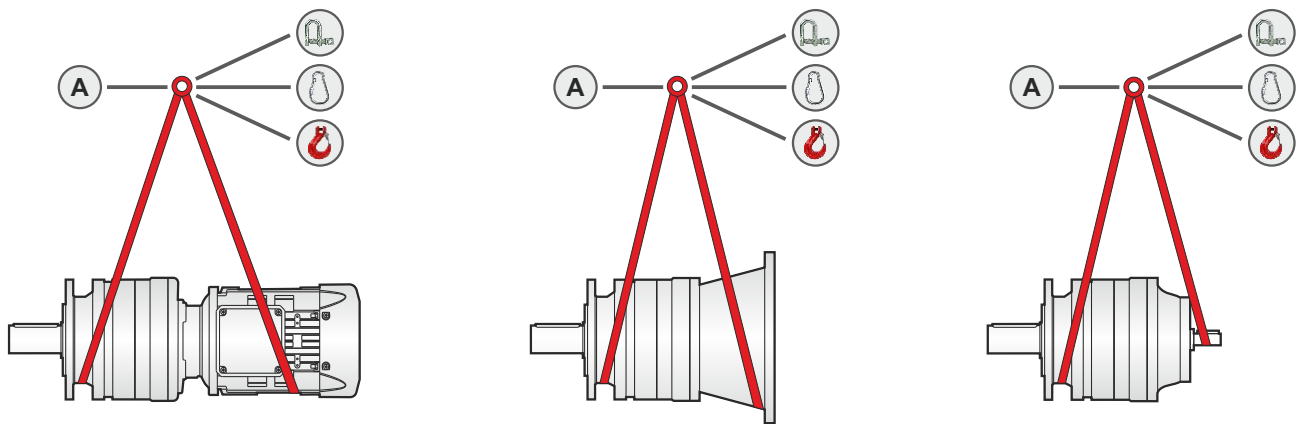

A Hoop equipped (swab)

Load hook

Screw hook

Locked hook

Manual lifting (Weight \leq 15 kg)
(ref. ILO Contract)
Not valid for the continuous carrying.



The allowable maximum slope is 15 degree.

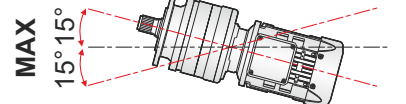

PL - PS

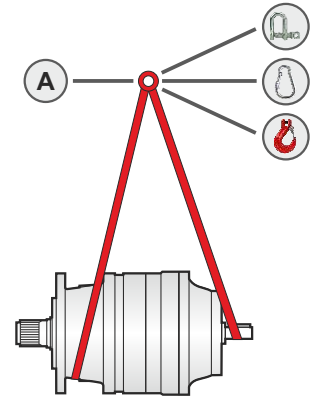
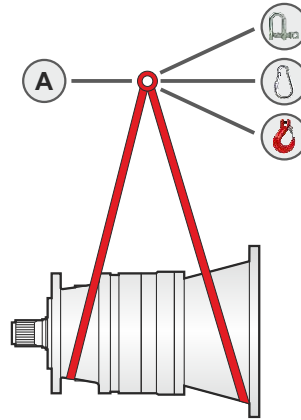
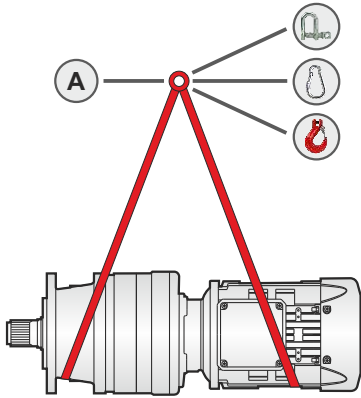

PL - PC

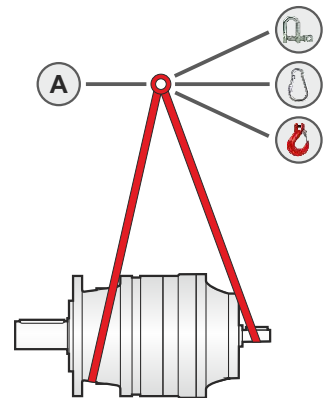
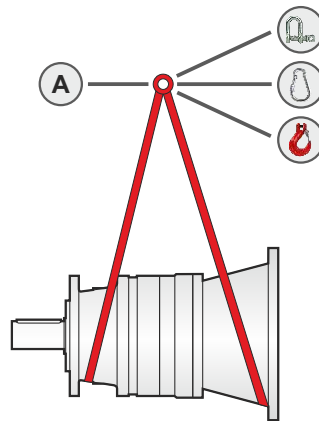
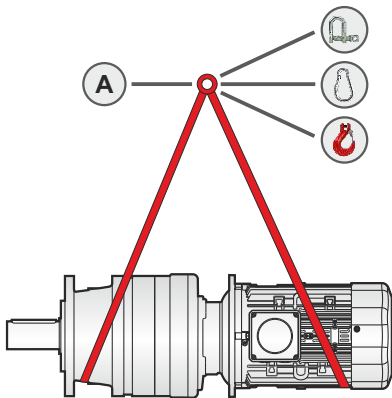

A Hoop equipped (swab)

Load hook

Screw hook

Locked hook

Manual lifting (Weight ≤ 15 kg)
(ref. ILO Contract)
Not valid for the continuous carrying.



The allowable maximum slope is 15 degree.

MAX

15° 15°

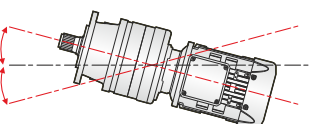

PL - FS

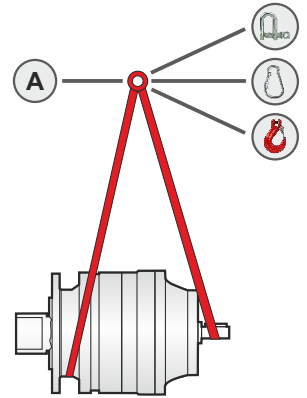
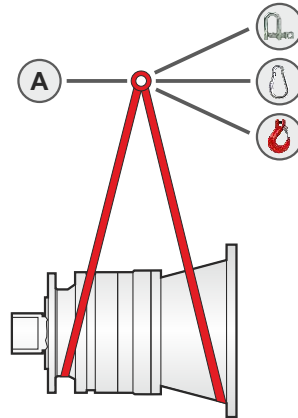
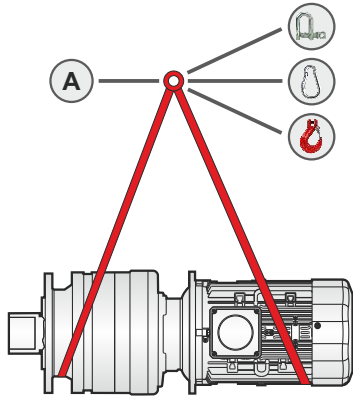

PL - F

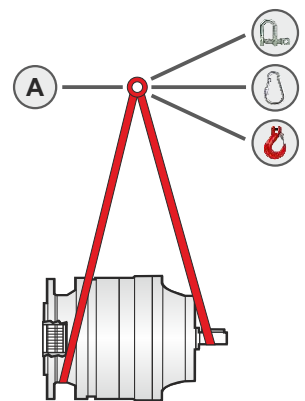
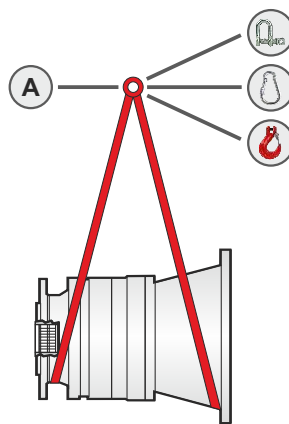
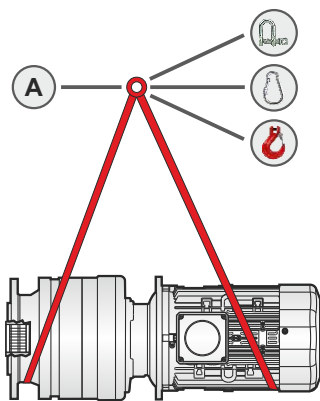

A Hoop equipped (swab)

Load hook

Screw hook

Locked hook

Manual lifting (Weight ≤ 15 kg)
(ref. ILO Contract)
Not valid for the continuous carrying.



The allowable maximum slope is 15 degree.

MAX

15° 15°

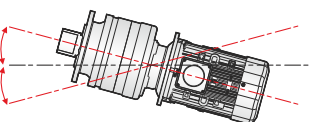

PL - CPC

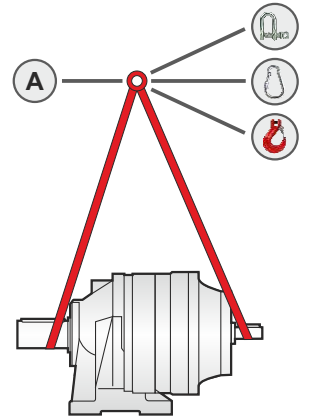
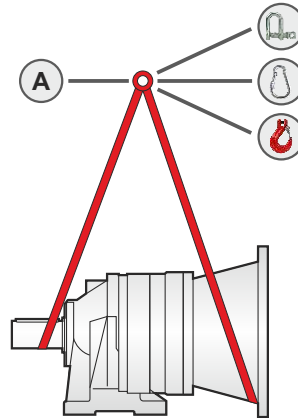
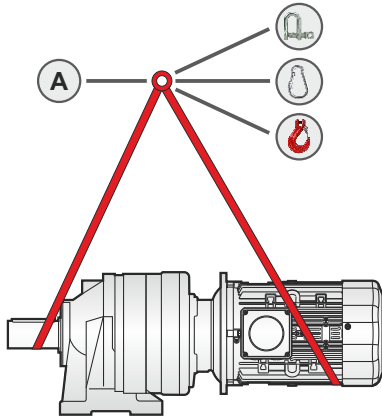

A Hoop equipped (swab)

Load hook

Screw hook

Locked hook

Manual lifting (Weight ≤ 15 kg)
(ref. ILO Contract)
Not valid for the continuous carrying.



The allowable maximum slope is 15 degree.

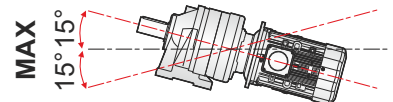

PL - MS

PMRV / PRV

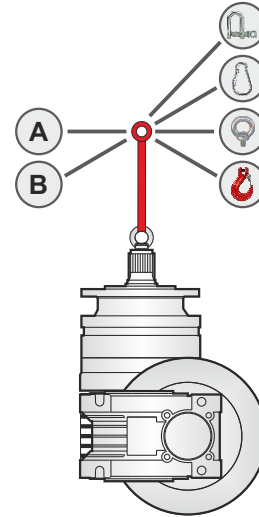
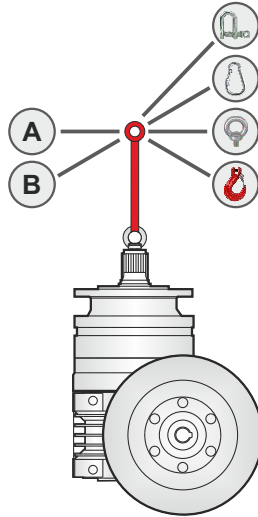

PL - MC

PMRV / PRV

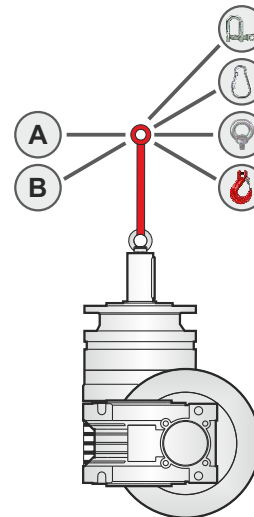
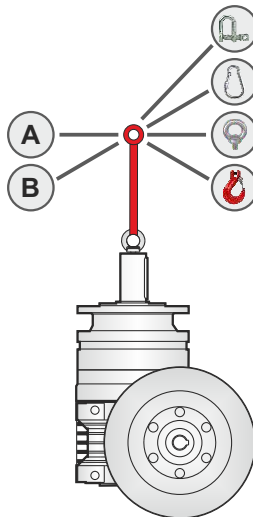

A Hoop equipped (swab)

Load hook

Locked hook

B Hoop equipped (chain)

Screw hook

Lifting eyebolts

Manuel lifting (Weight ≤ 15 kg)
(ref. ILO Contract)
Not valid for the continuous carrying.



The allowable maximum slope is 15 degree.

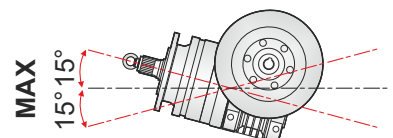

PL - PS

PMRV / PRV

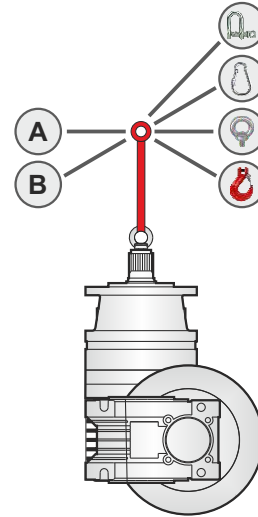
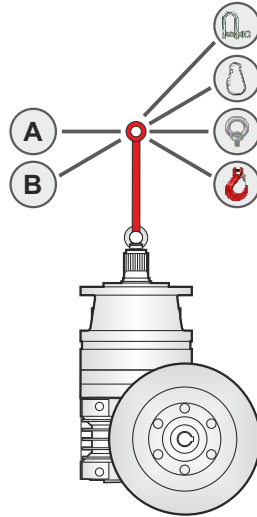

PL - PC

PMRV / PRV

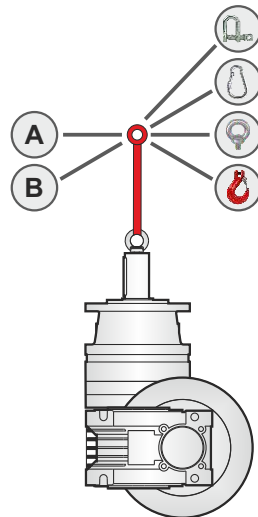
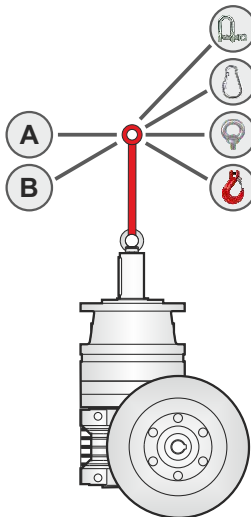

A Hoop equipped (swab)

Load hook

Locked hook

B Hoop equipped (chain)

Screw hook

Lifting eyebolts

Manuel lifting (Weight ≤ 15 kg)
(ref. ILO Contract)
Not valid for the continuous carrying.



The allowable maximum slope is 15 degree.

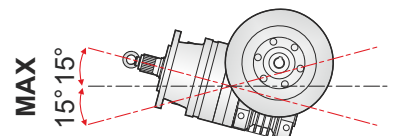

PL - FS

PMRV / PRV

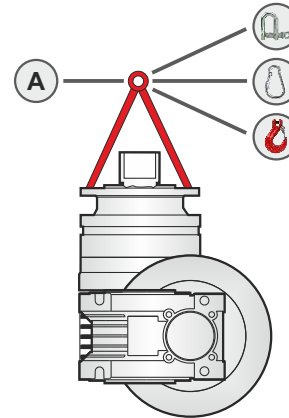
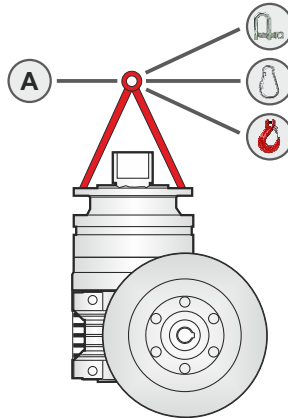

PL - F

PMRV / PRV

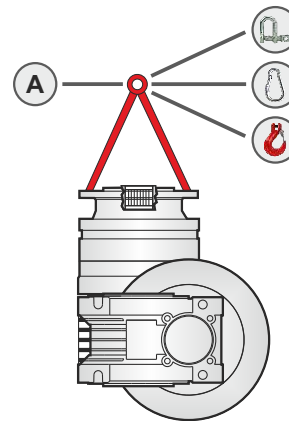
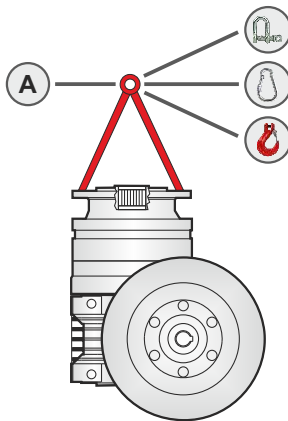

A Hoop equipped (swab)

Load hook

Screw hook

Locked hook

Manual lifting (Weight \leq 15 kg)
(ref. ILO Contract)
Not valid for the continuous carrying.



The allowable maximum slope is 15 degree.

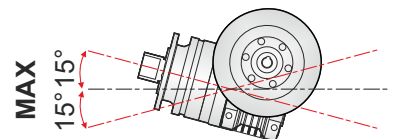

PL - CPC
PMRV / PRV

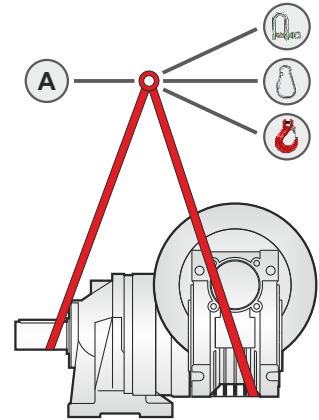
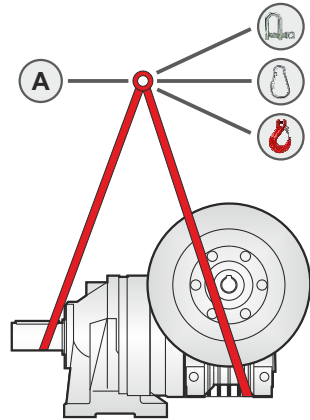

A Hoop equipped (swab)

Load hook

Screw hook

Locked hook

Manuel lifting (Weight ≤ 15 kg)
(ref. ILO Contract)
Not valid for the continuous carrying.



The allowable maximum slope is 15 degree.

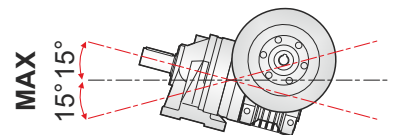

PLB - MS

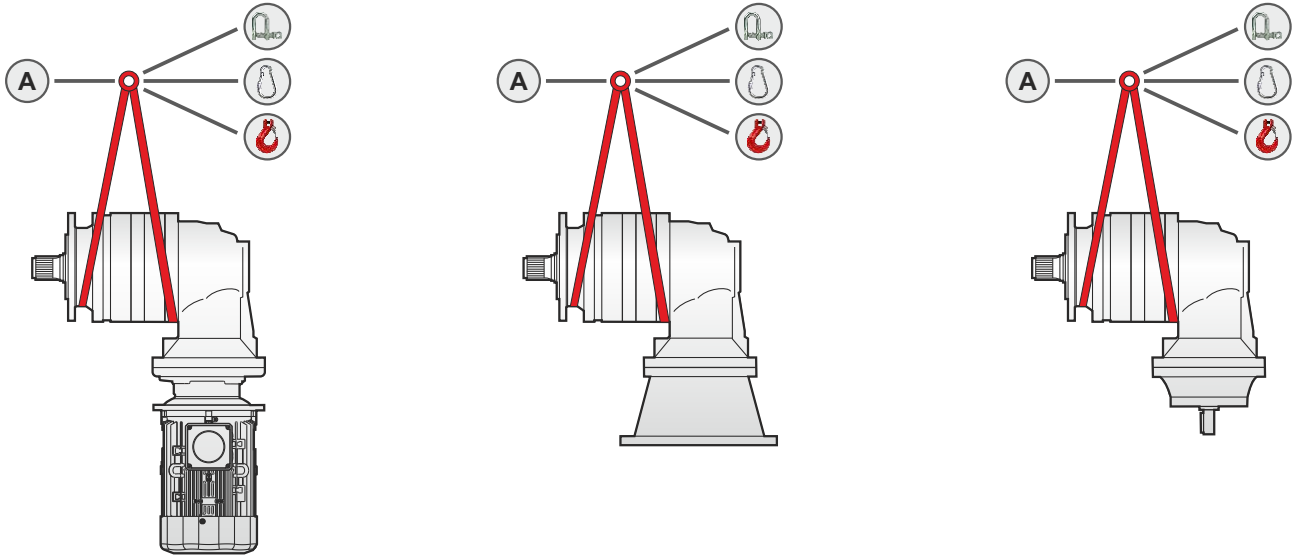

PLB - MC

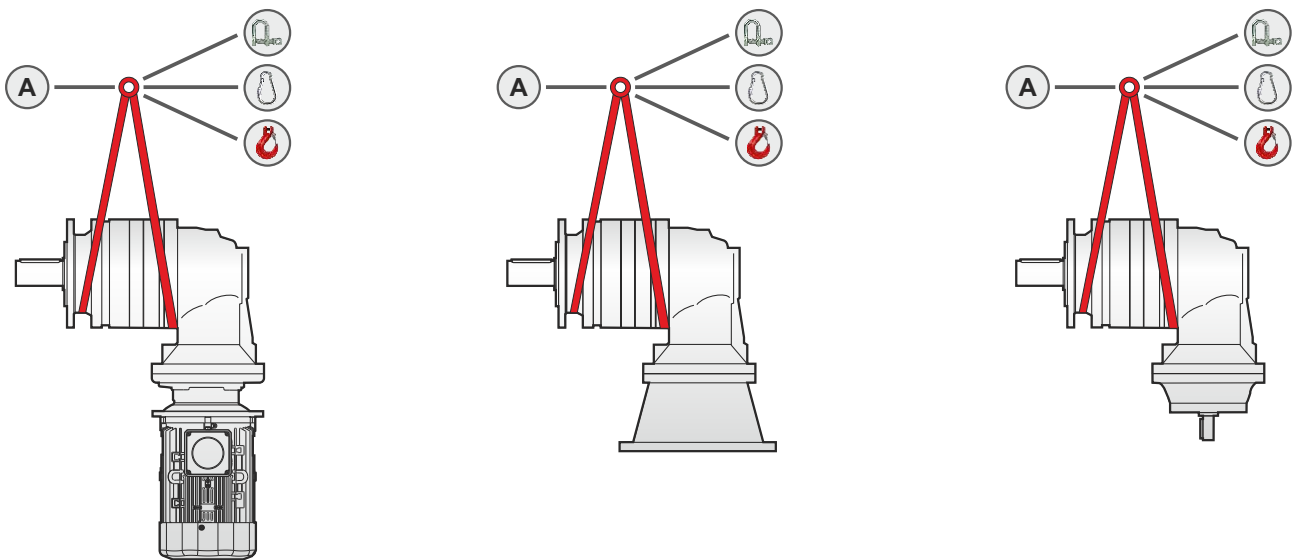

A Hoop equipped (swab)

Load hook

Screw hook

Locked hook

Manual lifting (Weight ≤ 15 kg)
(ref. ILO Contract)
Not valid for the continuous carrying.



The allowable maximum slope is 15 degree.

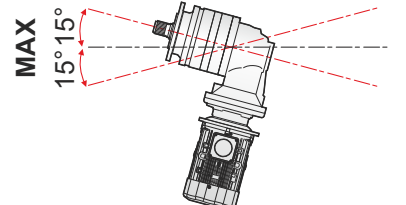

PLB - PS

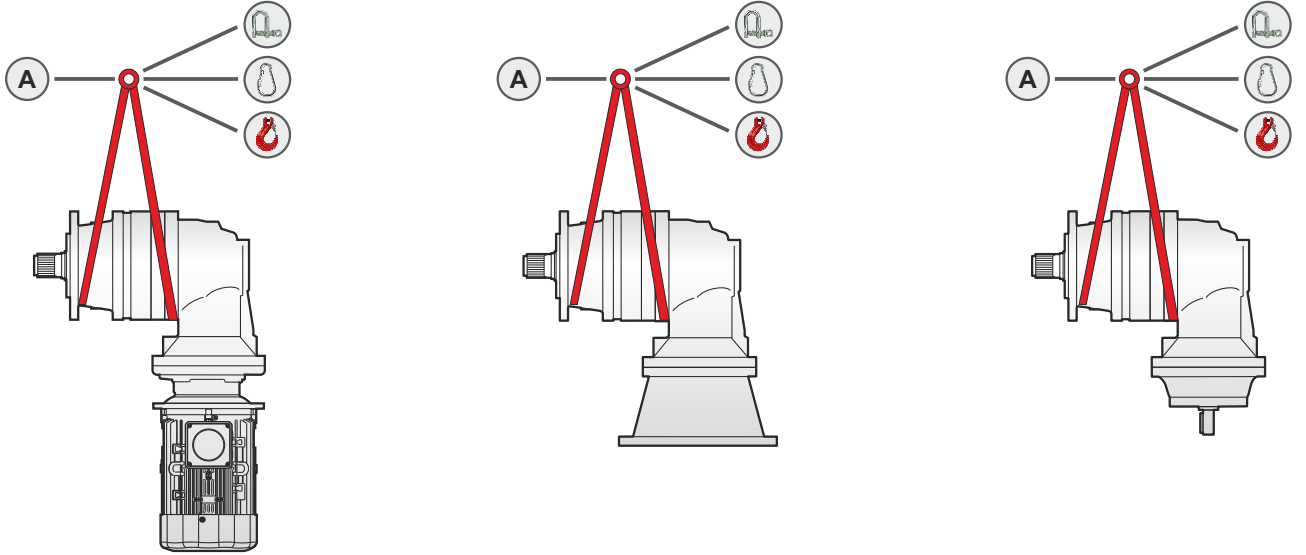

PLB - PC

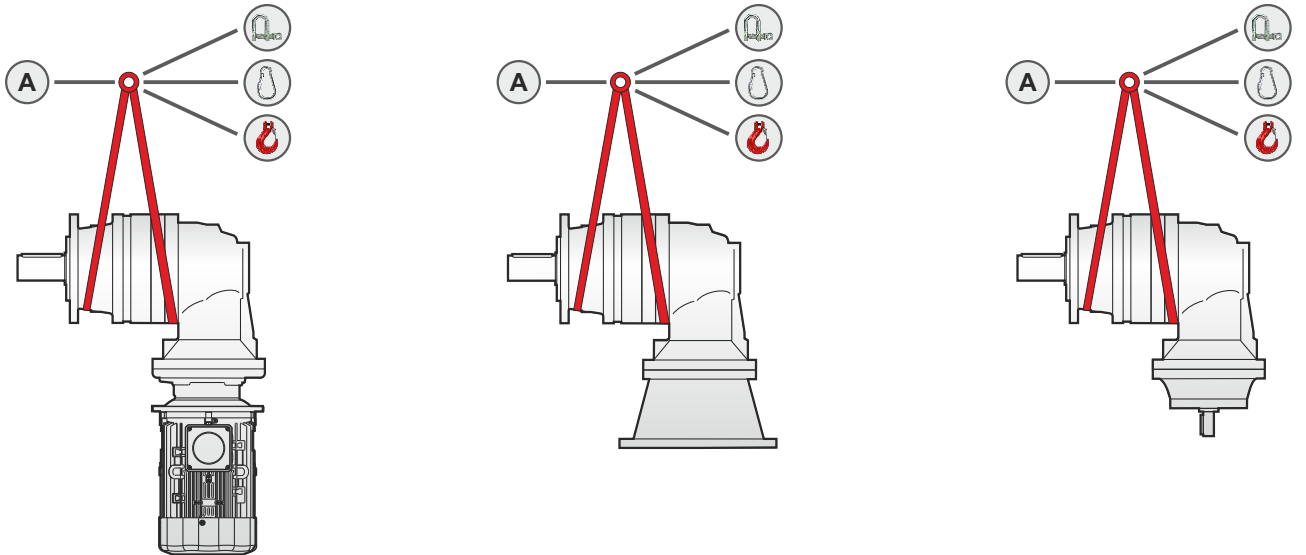

- A** Hoop equipped (swab)
- Load hook
- Screw hook
- Locked hook

Manual lifting (Weight ≤ 15 kg)
(ref. ILO Contract)
Not valid for the continuous carrying.



The allowable maximum slope is 15 degree.

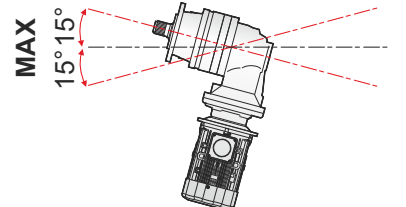

PLB - FS

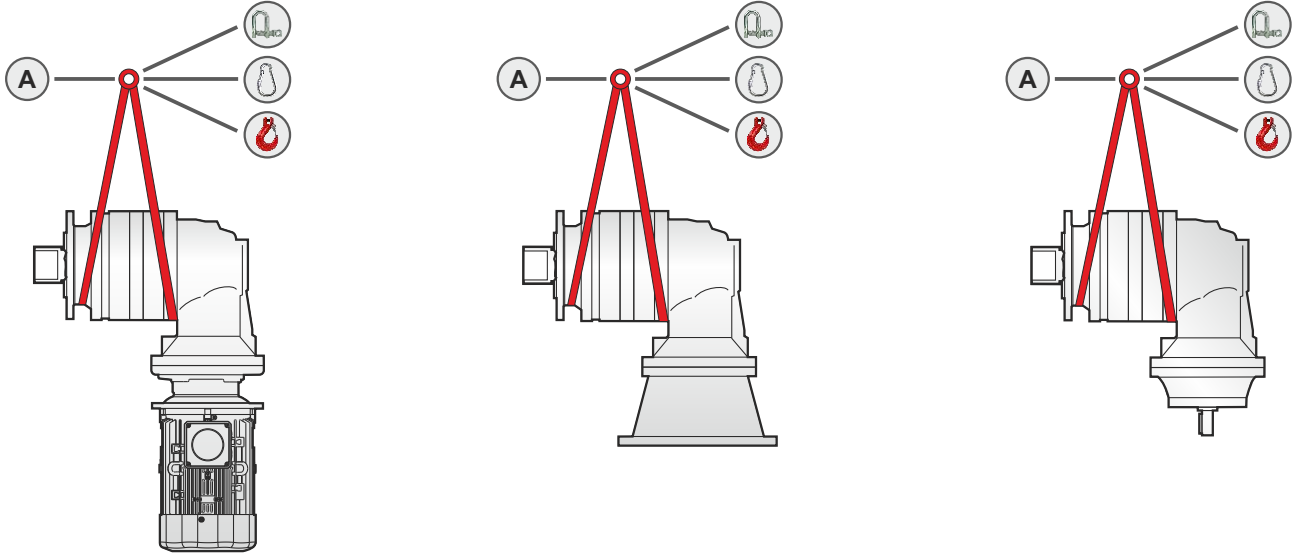

PLB - F

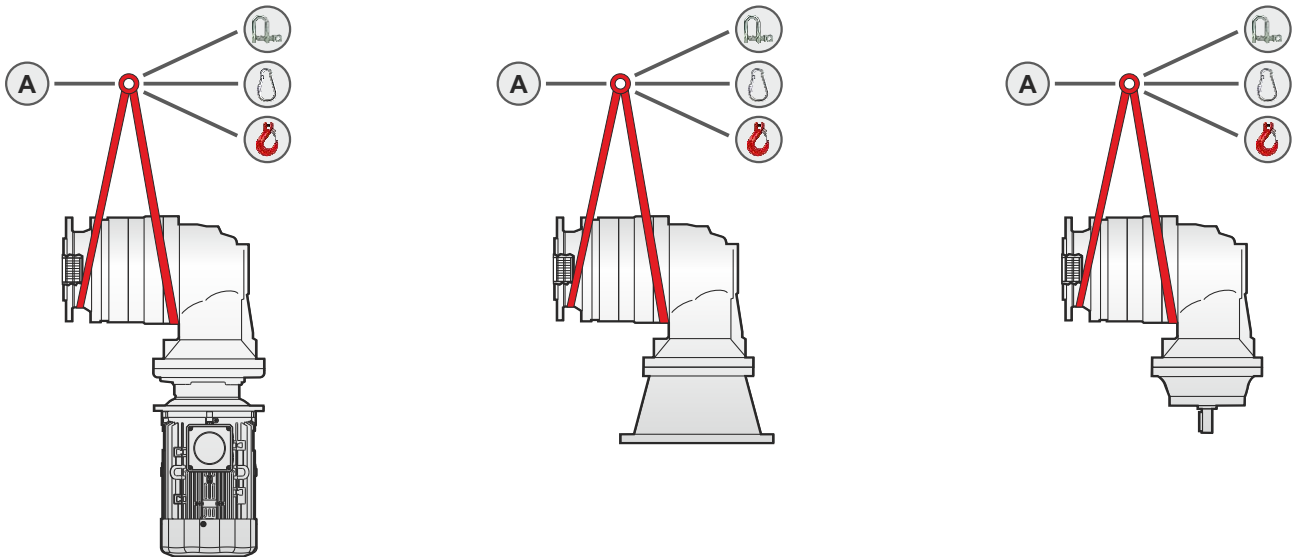

A Hoop equipped (swab)

Load hook

Screw hook

Locked hook

Manual lifting (Weight ≤ 15 kg)
(ref. ILO Contract)
Not valid for the continuous carrying.



The allowable maximum slope is 15 degree.

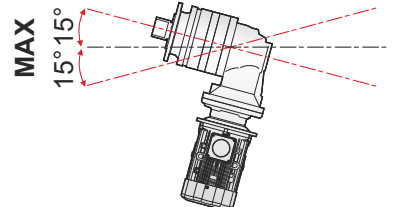

PLB - CPC

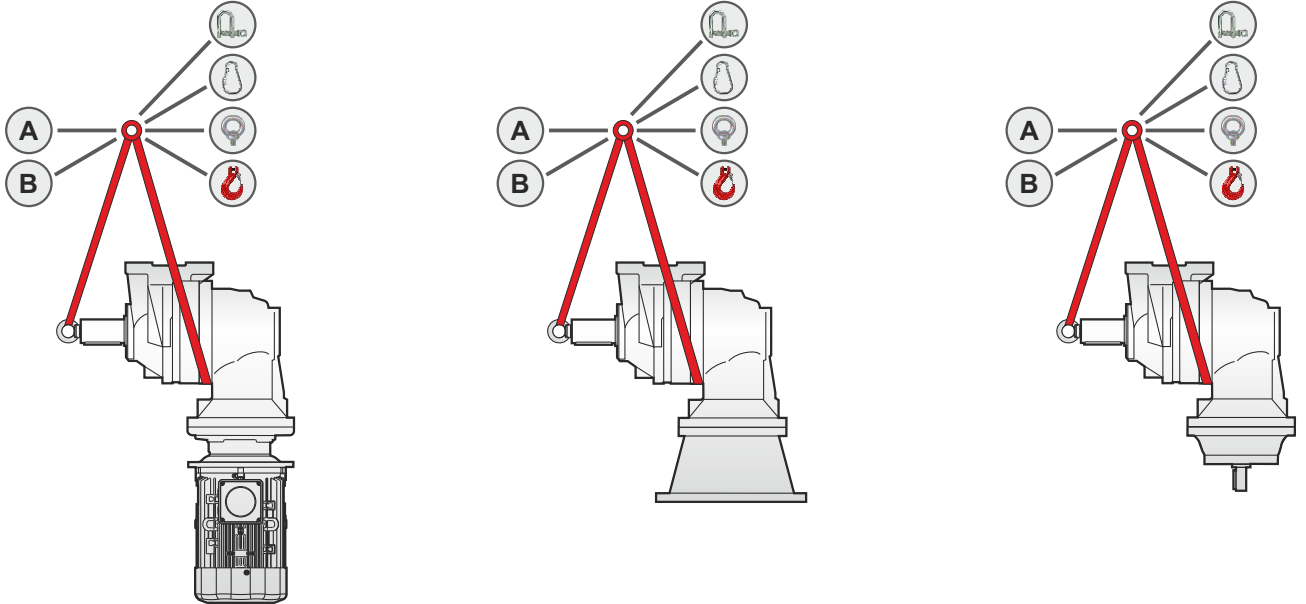

- A** Hoop equipped (swab)
- B** Hoop equipped (chain)

- Load hook
- Screw hook

- Locked hook
- Lifting eyebolts

Manuel lifting (Weight ≤ 15 kg)
(ref. ILO Contract)
Not valid for the continuous carrying.



The allowable maximum slope is 15 degree.

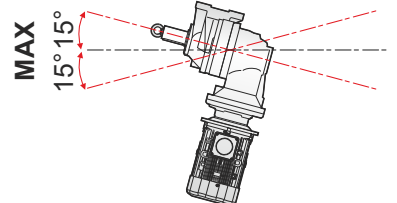

1.7 Storage

The certain suggestions have given about the storage conditions of the gear unit/gear unit with motor below;

- In clear and moist-airs, the storage should not be made.
- The gear unit/gear units with motor should not directly be contacted to the ground.
- The place must be moveless where the both gear unit/gear units with motors are contacted. Otherwise there could be damage during the movement.
- The gear unit should be got into the secure to the falling.
- The processed surfaces of the gear units and both solid and hollow shafts must be lubricated with protective oil.
- Gear unit/Gear units with motors must be in the place where there will be no big temperature differences between -5 °C and +40 °C.
- Relative humidity must be less than %60.
- Not directly be exposed to sunlight and infraded light.
- Must be kept away from the abrasive materials which causes corrosion (dirty weather, ozon, gases, solvents, acids, salts, radioactivity, etc.) in environment.
- The protective oil SHELL ENSIS or similar product should be used on the corrodible pieces.
- If the gear unit is without oil, it must be filled with lubrication oil.

**EXPLOSION !**

Gearboxes during storage;
Provide protection of unpainted and processed areas by lubricant. In case of areas getting rusted, ATEX certificate will be no longer valid.

**EXPLOSION !**

These processes should be made far away from explosive atmosphere.
If there is an unproper oil inside of gearbox to operate, this oil must be discharged and be cleaned.

**SECURITY MEASURES !****Precautions to be taken when returning the gear unit to service after storage:**

The output shafts and external surfaces must be thoroughly cleaned of all rustproofing product, contaminants and other impurities (use a standard commercial solvent).



Do this outside the explosion hazard area. The solvent must not touch the seal rings as this may damage them, causing them to leak.

If the oil or protective material used during storage is not compatible with the synthetic oil used during the machine's operation, the interior of the unit must be thoroughly cleaned before filling with the operating oil.

The service life of the bearing grease is reduced if the unit is stored for more than 1 year. The bearing grease must be synthetic.



1.7.1 Long Term Storage Suggestions;

	NOTE ! <ul style="list-style-type: none">- In the long-term storage or during the short-term storage, if the excessive temperature differences occur, the oil in the gear unit must be changed before the operating.- In the fully oil filled gear unit, the oil level should be reduced according to the mounting position.
	ATTENTION ! <ul style="list-style-type: none">- The incorrect and excessive long storage could cause the gearbox getting defected.- Please control not to exceed allowed storage period before starting up the gearbox.
	NOTE ! <ul style="list-style-type: none">- PGR, recommends long-term storage option for periods of more than 9 months holding and pausing times.- By paying attention both to the long-term storage option and precautions which listed below, the holding of goods up to 2 years could be possible. Because of real efficiency of gearboxes depending on local conditions widely, these periods could be seen solely guide values.

Long term storage suggestions;

- Mineral oil or synthetic oil according to mounting position is filled of getting available for operating. Despite this, the oil level should be controlled before operating.
- The VCI Corrosion protected tool are mixed into the gear unit's oil.
- The carrying safety of the ventilation plug must not be removed during the storage.
- The gear unit must be closed to the shape of unsealed.
- In case of storing axial piston or orbit type hydraulic motorized gearboxes, the motors would be filled with lubricant in order to prevent oxidation. (ISO VG 150 type). With the help of metal plugs and flaps, motor entrance and discharge hole are shut down.



2.1 Gear Unit Label

EXPLOSION !

Explosion hazard: Failure to comply may cause severe, or even fatal injuries. It must be checked and ensured that the gear unit type, all technical data and the ATEX labelling conform to the planning of the plant or the machine.

The type plate must be firmly attached to the gear unit and must not be subjected to permanent soiling. Please contact the PGR service department if the type plate is illegible or damaged.

EXPLOSION !

Gearboxes that are suitable to 2014 /34 /EU instruction; have "ATEX" label which is at the standard of EN ISO 80079-36:2016, EN ISO 80079-37:2016 and also proper to stated contents. **An example is given below:**

Figure 2: Gearbox Nameplate and Explanation

Marking according to ATEX (EN ISO 80079-36:2016, EN ISO 80079-37:2016):

1. Group (Always II, quarries are not included)
2. Category (for gas **2G-3G**, for powder **2D-3D**)
3. If firing protective type (**c**) is put
4. Implementing explosive group (**IIC, IIB**)
5. Temperature Class (for gas **T1-T3** or **T4**) or maximum surface heat (for example for powder **125 °C**) or specific maximum surface heat, look at private documents. (**TX**)
6. Temperature measurement during access to a plant. (**X**)

2.2 Compatibility Declaration

All gear units or gearmotors (when supplied with electric motor) are designed in compliance with the provisions of applicable Essential Health and Safety Requirements, the "Machinery Directive" 2006/42/EC and, if requested, can be supplied with a Manufacturer's Declaration-Annex IIB as provided by said Directive.

EXPLOSION !



The nameplate specifications regarding the maximum surface temperature, refer to readings taken in normal ambient and installation conditions. Even minimal variations to said conditions (e.g. smaller mounting cabinet) may have a significant effect on the unit's heat output.

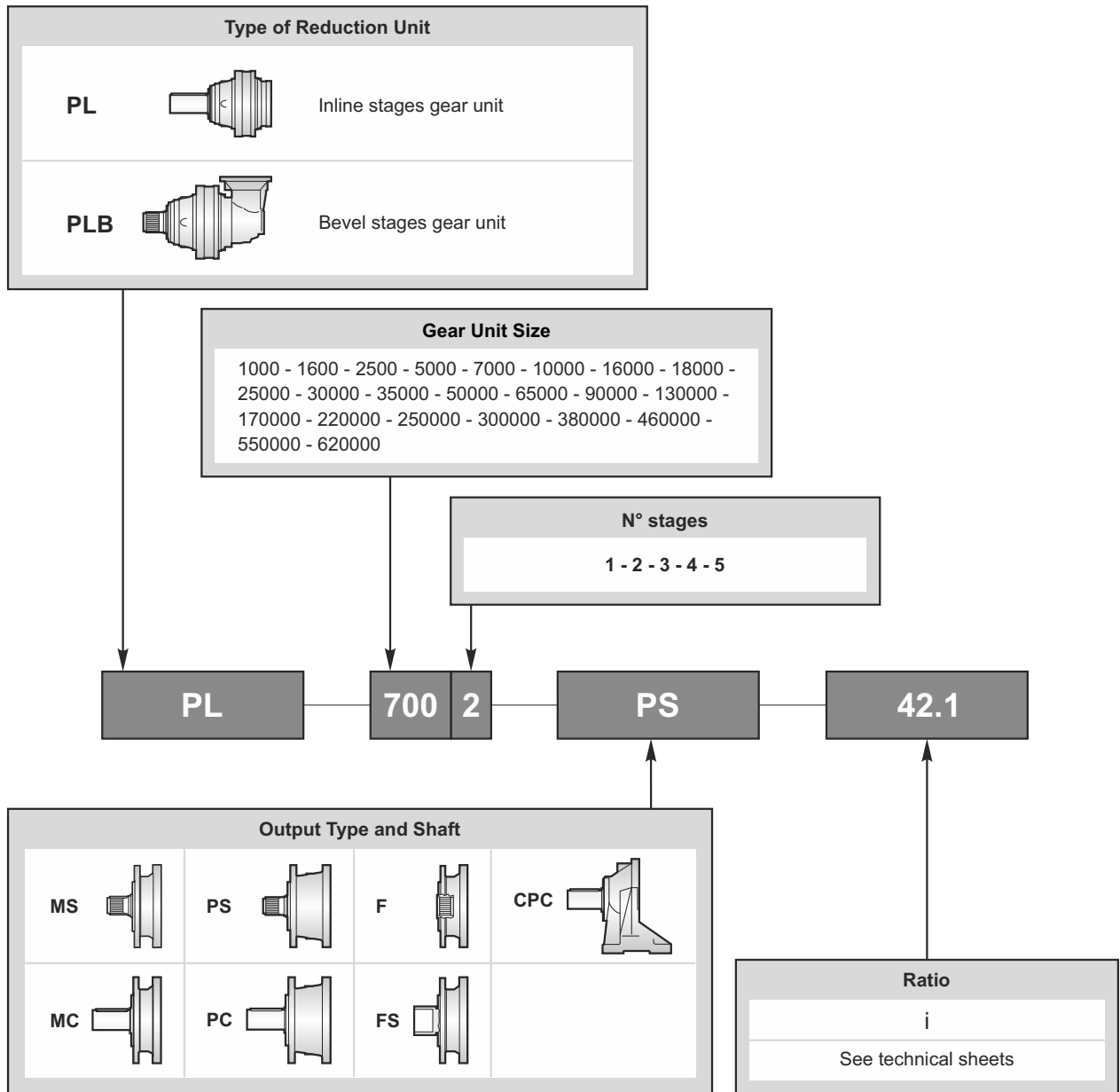

2.3 Explanations

Table 2: Product Description (Explanations)

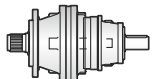

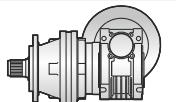
EXAMPLE FOR ORDERING	
PL 7002 PS 42.1 IEC90 B5 YZ FF	
PL 7002 PS 42.1 EML 42 B5	
PL 7002 PS 42.1 H.2074.013.018 B5 FL FF	
PL 7002 PS 42.1 PMRV63 20 90B14 C1	



2.3.1 Accessories

Table 3: Product Description (Accessories)

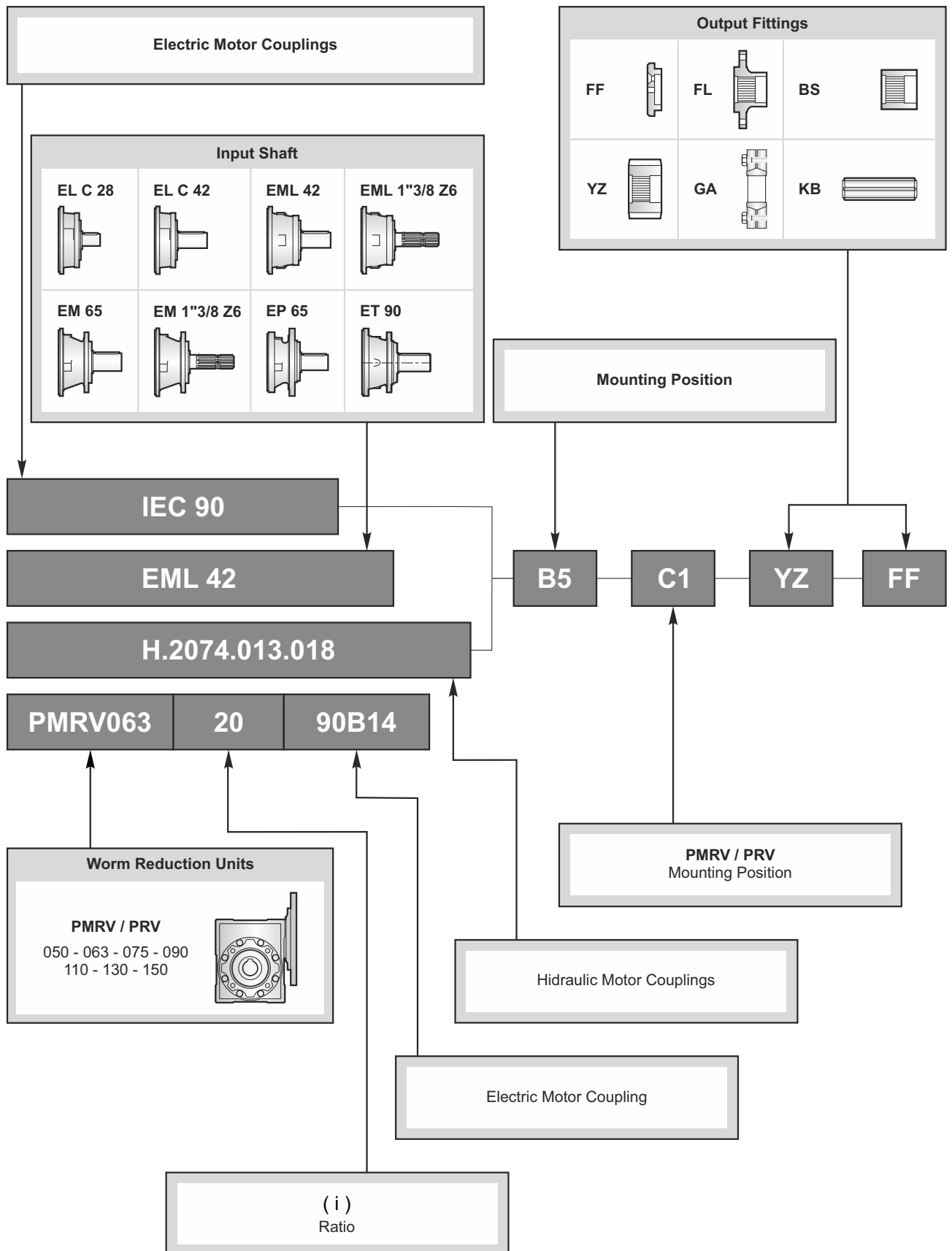



2.4 Abbreviations

Table 4: Abbreviations

Abbreviations	Meaning	Planet Gear Units
PL	Coaxial Gear Unit	✓
PLB	Bevelled Gear Unit	✓
MS	Mounting Flange and Splined Shaft	✓
MC	Mounting Flange and Keyed Shaft	✓
PS	Mounting Flange and Heavy Duty Splined Shaft	✓
PC	Mounting Flange and Heavy Duty Keyed Shaft	✓
F	Mounting Flange and Splined Hollow Shaft	✓
FS	Mounting Flange and Hollow Shaft	✓
CPC	Foot Mounted and Keyed Shaft	✓
ED	Direct Input Motor Adaptor Without Brake	✓
EDF	Direct Input Motor Adaptor With Brake	✓
EF	Direct Input Motor Adaptor With Brake	✓
RA - RB	Brake	✓
YZ	Pinion	✓
BS	Spline Coupling	✓
FL	Flange	✓
FF	Fixing Washer	✓
KB	Spline Shaft	✓
GA	Shrink Disc	✓
ELC - EML - EM - EP - ET	Input Shaft	✓
IEC	IEC Adapter	✓
PMRV	Worm Gear Unit Adaptors	✓

✓ : Existing designs are marked with a tick.



3.1 Prerequisites of Assembly

Take into the consideration which listed below;

- The informations placed on gear unit with motor in accordance with current network voltage.
- There could be no damage in the gear unit.
At standard gear units;
- The ambient temperature should be fitted temperature values given in the "Lubricant" part.

 	EXPLOSION !
<p>Before access to a plant, those belows should be controlled and be secured:</p> <ul style="list-style-type: none"> • During assembly of gearbox, whatever any explosion danger such as due to lubricant, acid, gas and steam radiation, could not be happened and there should not be powder accumulation at gearbox more than 5 mm. • During operating process, gearbox should be put in a well-vented room and not to be exposed in an effect of substantially heat radiation from outside. • During operating process, the temperature of cooling air should not exceed 40°C. • Controlling of lubricant and both discharging plugs and valves must be easily accessible. • Several other devices belong to gearbox, seperately from their own functions should have an ATEX Certificate. (Protective electrical working substance against explosion) • The setting of gearboxes which have hollow shafts (even if there may be a friction preventer connection or may not) should be made properly according to an instructions at this hand guide. • After set up process is completed, cleaning of gearbox would be required. • Please be sure that all parts expanding and shifting with help of machine operator or all operating devices which prevent unwanted contacts between gearbox gaskets, would be operativeness. 	

	DANGER !
<p>The Gear unit must not be mounted in the ambient conditions listed below:</p> <ul style="list-style-type: none"> - Explosive atmosphere, high corrosive and / or oils, acids, gases, steams, radiation, - Places directly contacted to the food. 	

Gearboxes are either dispatched without motor or motors by ATEX are assembled to a gearbox after getting supplied from electrical motor manufacturer. Electric connection belongs to end user.

At special applications the configuration of gear unit/gear unit with motor are realized convenient to the ambient conditions. Output shafts, processed surfaces, corrosion preventive material on the solid shaft/hallow shaft, jerks etc. must be cleaned.

Extensive usage-solvent must be used. The solvent should not be contacted to the bearing houses and sealing components.

In the abrasive ambient conditions, both output shaft, sealing components must be protected to the wearing Connection flanges must be attached to the hollow shaft/solid shaft according to DIN 332.





The situations where the wrong direction of rotation could caused to damages and dangers, before the mounting, the test work should implemented to the gear unit so the right direction of rotation could be determined and must got into the secure for the next operating.

In the one-way locked gear units, nibs are placed at the entry and exit side of the gear unit. The ends of the nibs shows the direction of rotation of the gear unit. During the motor connection and motor-operating with the help of magnetic field, the gear unit must be operated just at the direction of rotation.

	DANGER !
<p>In the one-way locked gear units, the gear unit must be operated at the direction of lock rotation, otherwise the damage could be occurred.</p>	

Around the mounting position, there must be suered that there are not any materials fused to metal, lubricating tool or elastomers which causes corrosion or will not be emerged.



 	<p>EXPLOSION !</p> <p>Maximum surface temperature states gotten measurements in normal setup and usage conditions. If the usage conditions of gearbox are different from those, surface temperature could up to higher values. In that case oil circulating cooling unit must be used.</p>
 	<p>EXPLOSION !</p> <p>In case of below actions that were taken, the ATEX Certificate will be invalid.</p> <ul style="list-style-type: none"> • Different using other than label values based on the gearbox. • Use in more dangerous area (explosive environment) other than stated level at the label of gearbox. • Use of gearbox in the area whose equipment class is I. (quarries under dangerous originated by fire-damp). • Use of gearbox at different forces apart from gotten one. • Changing of assembly position.

3.2 Gear Unit Mounting

The lifting eyebolts screwed to gear unit must be used in gear unit mounting.

- Mounting of gear unit/gear unit with motor to the machine and selection of mounting place are crucial.
- The convenient connection points must be determined for gear unit type. (Foot mounted or Flange mounted)
- Ventilation plug must be opened after the carrying process.
- The connection tools which attached during the mounting to the machine must be tightened convenient to the torc given at the table.
- Because of the voltage, for to avoid transferring additional forces to the gear unit, both the gear unit and driven machine shaft must be aligned.
- There should not be any welding process on the gear unit. In the welding processes, the gear unit must not be used as a bracket. Otherwise bearing and gear part could damaged.

	<p>ATTENTION !</p> <p>During the mountage, the voltage should not be emerged between the foot and flanges and allowed radial and axial forces would not be taken into consideration! Check whether if there is radial or axial leakage at the connection unit which is between PAM and output shaft.</p>
---	---

- The gear unit/gear unit with motor only could be mounted according to determined mounting position. After the delivery, in the case of changing mounting position the change of lubrication level and other precautions could be needed. Any failures to comply to the determined mounting position could damaged gear unit.

Please consult to PGR.

- The gear unit/gear unit with motor have to be structured to stand against motor weight and operating voltages. The machine which will be connected has to be structured to stand against the weight of the gear unit with motor and operating voltage. The surface where the gear unit is to be fixed must be straight, vibrationless and protected against torsion.
- The machine which gear unit/gear unit with motor will be connected, there must be sured that it is closed and not to be operated without intention.
- The sphere of the movable pieces out of the gear unit must be closed with the safety cabinet kit.
- The sunlight and the impact of the weather conditions must be prevented during the mountage of the gear unit to the outside machine. However the air circulation needed to be provided to the unit.
- Depending on the type of used gearbox, all the foot and flange bolts must be used completely. Bolts must be tightened with proper tightening moments.



- To prevent overloading of machine equipment which gearbox is connected, supply of extreme current breaker, temperature delimeter, extreme speed monitors etc. equipments by end user is required.
- During operation of urgent stopping system, accumulated energy should be swiftly and securely be distributed or would be isolated the way that no danger is created. Distribution of accumulated energy is related with system connected to the gearbox. Necessary precautions must be taken at those systems.



NOTE !

The opportunity of the easy access must be provided to the oil level plug, drain plug and ventilation plug.

The proper oil filling should be controlled according to mounting position. (Could be viewed on "lubricators/oil filling quantities" part or the values written on gear unit) The necessary amount of oil has filled to the gear unit/ gear unit with motor by our firm. The slight deviations in oil level plug are resulted because of the mounting position and within the production tolerances.

If there is any danger of the electro-chemical corrosion between gear unit and machine, plastic pieces (2-3mm) must be mounted between the connections. The electrical discharge resistance of used plastic material must be <10 Ω.

Electro-chemical corrosion could be occurred between the different metals like cast iron and stainless steel. Also plastic washer should be used in bolts!

3.3 Bolt Tightening Torque Value

Table 5: Bolt Tightening Moments

Bolt Tightening Moments [Nm]						
Dimensions	Bolt Quality			Cover Bolts	Coupling Bolts	Protective Cover Connection Bolts
	8.8	10.9	12.9			
M4	3.2	5	6	-	-	-
M5	6.4	9	11	-	2	-
M6	11	16	19	-	-	6.4
M8	27	39	46	11	10	11
M10	53	78	91	11	17	27
M12	92	135	155	27	40	53
M16	230	335	390	35	-	92
M20	460	660	770	-	-	230
M24	790	1150	1300	80	-	460
M30	1600	2250	2650	170	-	-
M36	2780	3910	4710	-	-	1600
M42	4470	6290	7540	-	-	-
M48	6140	8640	16610	-	-	-
M56	9840	13850	24130	-	-	-
G½	-	-	-	75	-	-
G¾	-	-	-	110	-	-
G1	-	-	-	190	-	-
G1¼	-	-	-	240	-	-
G1½				300		-



3.4 Gear Unit Ventilation

In moist places or in open air usage, the gear unit which is resistant to corrosion is recommended. The damages in paint (in ventilation plug) must soon be corrected.
The carrying safety of the ventilation plug on the gear unit is to be remove. If ventilation plug was sent separately, it has to be inserted.

Figure 3: Activation of Vent Plug

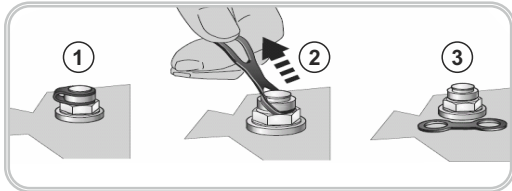

1. The carrying secured ventilation plug,
2. Remove the carrying safety,
3. The ventilation safety is active.

3.5 The Mountage of the Connection Tool to the Output Shaft

For the mountage of the output shaft tools look at the schema below.

Figure 4: The Mountage of the Connection Tool to the Output Shaft

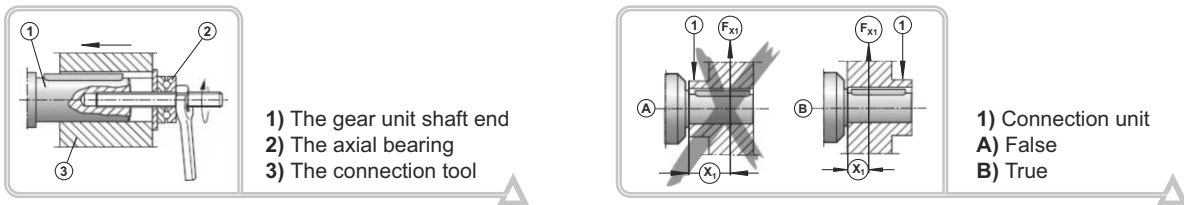

* To prevent high radial forces:the gear and sprocket must be mounted as seen in shape B.

For the mounting of the connection tools only pulling device must be used. For the position adjustment the bearing strip which is at output shaft end must be used.

	<p>NOTE !</p> <p>The belt and pulleys, couplings, gears and etc. Must not be installed with hammering to the shaft end. Otherwise there could be a damage in body, bearings and shaft. In belt and pulleys, the rightness of the belt voltage must be paid attention. (suitable to the producer's data). For the not emerging of disallowed radial and axial forces, balance adjustment of the connection tool must be made.</p>
--	---

	<p>NOTE !</p> <p>With smearing a little amount of grease or heating the connection tool in a short-time (80....100 °C), the mounting easiness may be provided.</p>
--	---



3.6 Temperature Sticker

	EXPLOSION !
	<p>Explosion hazard: due to lack of labelling. Failure to comply may cause severe, or even fatal injuries. With temperature class T4 gear units or gear units with a maximum surface temperature of less than 135 °C, the supplied self-adhesive temperature sticker (printed with value 121 °C) must be affixed to the gear unit housing.</p>

The temperature class or the maximum surface temperature can be seen from the ATEX labelling in the last line of the type plate.

Examples: II 2G c IIC T4 X or II 3D 125 °C X

The temperature sticker must be affixed next to the oil level screw and (please see chapter 4.12 "Temperature Measurement" page 38-39) towards the motor. For gear units with an oil level vessel, the temperature sticker must be affixed in the same position as for gear units without an oil level vessel. For gear units which are lubricated for life, without oil maintenance, the temperature sticker should be affixed next to the type plate.

Figure 5: Temperature Sticker 1

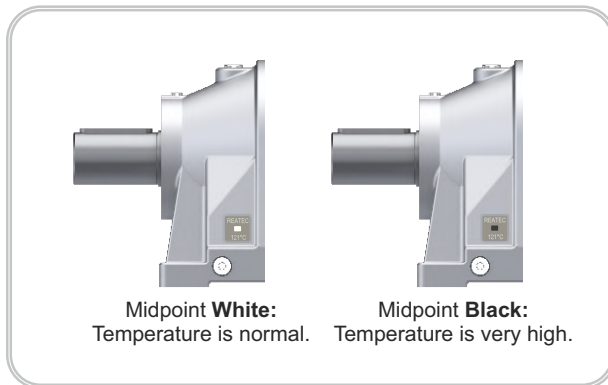

3.6.1 Visual Inspection of the Temperature Sticker

	EXPLOSION !
	<p>Explosion hazard: Failure to comply is likely to cause severe or even fatal injuries.</p> <ul style="list-style-type: none"> • Check whether the temperature sticker has turned black. • If the temperature sticker has turned black, the gear unit has become too hot.

The cause of overheating must be established. Please contact the PGR service department immediately. The drive unit must not resume operation before the cause of overheating has been remedied and renewed overheating can be ruled out. Before putting into operation again, a new temperature-sensitive adhesive label must be attached to the gear unit. Remove dust (only necessary for category 2D)

	EXPLOSION !
	<p>Explosion hazard: Failure to comply is likely to cause severe or even fatal injuries.</p> <ul style="list-style-type: none"> • Dust deposits on the gear unit housing must be removed if they are more than 5 mm thick.



3.7 The Mountage of the Couplings

While the couplings are mounting, it's balances must be made suitable to the datas of the producers. Must be implemented with suitable clamping device. Before mounting with the smearing of corrosion oil material to the solid output shaft/hollow shaft, mounting and demounting processes may be eased.

Figure 6: The Mountage of the Coupling

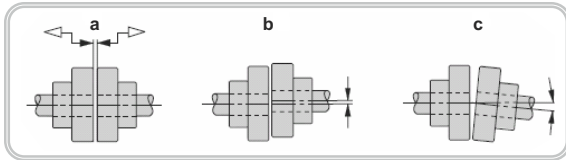

- a. Maximum and minimum distance
- b. Axial displacement
- c. Angular displacement

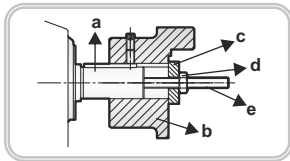

A basical clamping device example;

- a. The solid output shaft
- b. The coupling
- c. The washer
- d. The nut
- e. The stud



ATTENTION !

The belt-pulley, chain and gear drives must be protected from the contact of the external effects.

3.8 The Mountage of the Standard B5 Motor to the PAM Gear Unit

1. The motor and the solid output shaft of the motor with PAM adapted, flange surfaces must be cleaned and damage control must be made. The sizes and tolerances of the motor fixing elements must be suitable to EN 60079-0.
2. Must be pushed till to stand to the block of motor solid output shaft.
3. If the mountage is to be done in open air and the environment is wet, it is recommended that the surfaces of the motor flange and PAM adaptor have to be isolated. Before and after the motor mounting, in the shape of flange is isolated, loctite 574 or loxeal 58-14 surface isolation material should be used to flange surfaces.
4. The motor, must be installed to PAM adaptor.
5. The bolt of the PAM adaptor has to be mounted with suitable tightening moment.

Figure 7: The Mountage of the Standard B5 Motor to the PAM Gear Unit

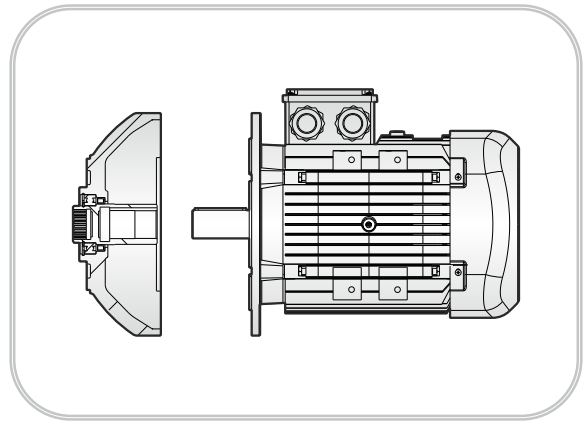

EXPLOSION !

- If all controls that were stated above are positive and all instructions were performed completely/properly, electric motor could be set up with ATEX protection that is suitable to the gearbox and in the same way 2014/34/EU regulation adaptable a gearbox motor could be generated.

Although during the connection of motor and gearbox, in the use of a process which is not stated in this handbook and/or not follow a single or more instructions, the operator should calculate analysis and must define by himself that the risk could emerge from motor-gearbox connection. In the situation of gearbox would be feeding motor, this risk analysis will always be required.

Only just in this manner, complete system would be subject to both certificate of manufacturer and 2014/34/EU regulation adaptable gearbox.



3.9 The Demountage of the Electrical Motor (PAM)

During the operating, it is crucial that the surface of the connection tool between the motor and gear unit is not rusted, for the removal of the motor not to exercise excessive load is necessary. During the separation of motor from the gear unit without forcing, the method at the below must be implemented. Must be avoided the implementations that causes strain and harm to the gear unit.

Figure 8: The Demountage of the Electrical Motor (PAM)

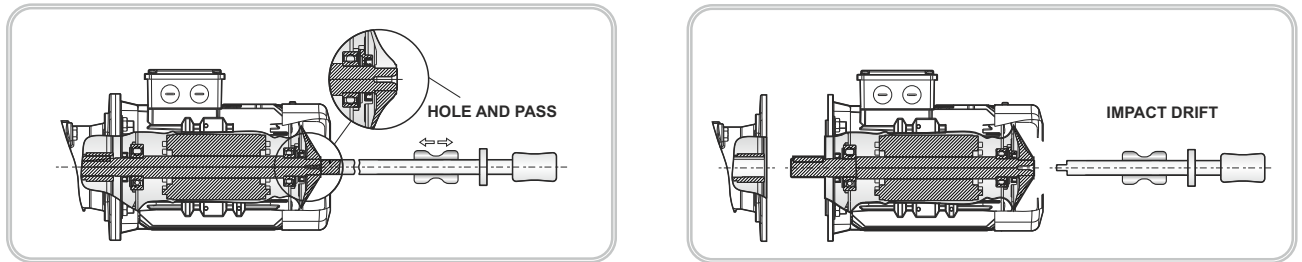

1. By fan with drilling the motor solid output shaft, the thread cutting must be opened.
2. The impact drift has to be installed to the threaded place.
3. The connection screws between the motor and gear unit must be removed.
4. By the help of impact drift inertial force, the motor must be separated from the gear unit.

The use of slots in the body of PAM, with the help of screwdriver or lever in a way that the motor is not harmed, may be removed by pushing back.

3.10 Gear Unit Operating

- The gear unit is tested firstly at our firm. (leakproofing test, noise test, torc test)
- For the confirmation of direction of rotation of gear unit, it is needed to be operated before machine mounting.
- The mounting of gear unit to the machine is needed to be convenient to 2006/42/EC and other safety standards.
- The electrical motor is needed to cover EN 60204-1 and EN 60079-0 standard.
- The mounting position of the gear unit should be as same as tag values.
- The datas in power units should be tolerated (plus, minus) %10 according to values specified in tag.
- There must not be any oil leakage in gear unit.
- There must not be extremely vibration and must not exceed acceptable voice decibel for gear units.
- In the situation of long-term non-usage, the storage conditions are needed to be implemented.
- The oil position must be controlled for the mounting position specified in catalogue.
- The oil level must be controlled.
- Before the operating, the carrying safety of the ventilation plug on the gear unit is needed to be removed.
- If the gear unit is dispatched without oil, the first oil filling must be loaded according to oil quantity stated in oil tables.
- It is not allowed to operate in sensitive areas against explosion. For these conditions, specific motors are available. Please consult to our firm.



4.1 Control and Periodic Maintenance

 	<p>EXPLOSION !</p> <ul style="list-style-type: none"> • Please obey to the routine inspection and maintenance periods, because only with this way required working conditions and explosion protection could be generated. • Please lubricate all gears again by Loctite 510 paste or something who has similar effect and usage. • Before repair and maintenance studies at the inner materials and opening of caps, to prevent emerge of any burning danger that could be originated by hot items, the gearbox should completely be cooled. • After maintenance studies, it will be sured that all available security systems were set up properly again and is operated. • After completing maintenance and repair studies, the cleaning of gearbox is required. • After getting finalized of maintenance studies, please retighten all oil, level and ventilation plugs with projected clamping torques. (also see 4.6 Oil Plugs Clamping Torque Chart, page 37) • After completing each maintenance intervention, it is required to apply gasket liquids onto them which creates a path to reconstitute those gaskets. • After following changing of a single gasket, independent from device type, before starting assembly processes, a thin layer fluorocarbon gel 880 ITP or some other product which has same effect and usage should be applied. • In all repairs, only original spare parts should be used.
------	--

	<p>NOTE !</p> <p>The maintenance and periodic maintenance works are performed by qualified person/operator who is well-educated and is sufficient in electric and mechanic issues; the rules convenient to job health and safety and specific environmental problems are performed as protected.</p>
--	---

	<p>DANGER !</p> <p>Before the start of the maintenance work of the gear unit, gear unit should be closed at first (get into the voltage-free position), be sured service-free, needed to take measures against any accident or spinning items with the help of unexpected external load. Also all environmental safety precautions must be taken.</p>
--	--

 	<p>EXPLOSION !</p> <p>Before starting whatever maintenance process, be sured that there is no any potential explosive atmosphere. The maintenance should be made by one who works appropriate to the accident prevention rules within the shape of guaranteeing security of other persons.</p> <p>At every 1000- hour time operation;</p> <p>During checking process, please control surface temperature at the hottest place that is detected. For the specific usage category (gas/powder) of achieved maximum temperature, it should be under the temperature which is given at the label. If temperature exceeds 130 °C, please stop machine immediately and get in contact with PGR.</p> <p>At every 5000-hour time operation;</p> <p>Please control and/or change abrasion and wearing situation of seals.</p>
------	--



- Before the maintenance process, all safety equipments are needed to get ready and if necessary the outside personal should be warned. The border around the unit must be specified and must prevented equipment entrance to the area. If any failures to comply to these conditions, the situations which causes harm to health and safety could be occurred.
- Worn items only must be changed with original and unused items.
- The lubricators, which recommended by our company, should be used. (see. **6.3 Lubrication Table**, page 55)
- The leakproofing items on the gear unit must be changed with original items.
- If the bearing is needed to be changed please contact to our firm.
- After the maintenance work, we recommend to change the lubrication oil.

All above informations were given for the purpose of efficient and confidential operating of gearboxes. Our firm is not responsible for substitute product and unroutined maintenance that causes damages and woundings.

When purchasing gear unit, should be noted that it is original product and has technical informations written in catalogue.

	<p>NOTE !</p> <p>The polluted oil and rusted items must not be left to the environment after the maintenance. These items must be disposed convenient to the regulations.</p>
--	--

 	<p>EXPLOSION !</p> <p>Before operations and services that are going to be made at gearboxes which operate in potentially explosive areas, be sured that the system is closed and all precautions were taken against possible re-operating.</p> <ul style="list-style-type: none"> • It is also vital to be sured that there is not any potentially explosive atmosphere during service and Maintenance processes.
------	---

 	<p>EXPLOSION !</p> <p>Please clean both dents on gearbox and exterior surface periodically and do not allow powders to accumulate more than 5 mm.</p>
------	--

Table 6: Control and Periodic Maintenance Ranges - Works

Control and Periodic Maintenance Ranges	Control and Periodic Maintenance Works
Once at every 3000 work hours or once at every 6-months until the	<ul style="list-style-type: none"> - Visual inspection - Check for running noises - Check oil level
80 work heat. Once at every 10.000 work hours or once at least in two years (the synthetic oil is once at every 20.000 work hours or once at every four years)	<ul style="list-style-type: none"> - Change the oil - The change of the ventilation plug
At least every 10 years	<ul style="list-style-type: none"> - General overhaul.



4.2 Visual Inspection

Controlling whether there is any oil leakage exists or not should be made at gearbox. There must be controlled that if there is oil filled or not in gear unit. Should be controlled that if there is any damage in gear unit's items and whether if the connection spots are rusted. Also must be controlled that if any cracks could emerge in hose connection lines and in rubber wedges. Leakproofing likes of dripping of gear unit's oil or dripping of cooling water and in damages and cracks, repair of the gear unit must be provided. Like these situations please get in contact with PGR.

Because of the storage and carrying, before the operation of gear unit and during at first operation, low amount of grease could flow out from bearing, this type of oil leak could not create any technical failure, the safety of gear unit and bearing operation could not be effected.

	NOTE !
	Must be sured that there is not air in hydraulic circuit.

4.3 Check for Running Noises

The emerge of unusual operation voice or vibrations in gear units could mean damages. In this type of situations, the gear unit must be stopped and overall revision must be made.

4.4 Control of the Lubricant and Lubricant Level

- Regular oil level controlling must be made.
- The electrical connection of motor must be cut and must got into safety form to prevent for reactivating.
- Must be waited until the gear unit got cooled.
- If the mounting position is changed, the section of "the mounting of gear unit" must be got into attention.
- A little amount of oil must be taken out of the oil drain plug. The quality of oil must be controlled.
- The oil must be changed when the sign of extremely oil pollution is seen.

4.5 Changing the Oil

To prevent the emergence of the danger of burning, must be waited until the gear unit got cooled. The oil level, draining and position of ventilation plugs are dependent on mounting position. For the mounting position, related pages from catalagoue could be seen. When the oil-changing process, the gear unit should be at operating temperature. The electric connection of motor driving unit must be cut and got into safety for re-activation.

	NOTE !
	Because of the coldness of oil will affected the flowing and venting, the gear unit must not be cooled fully.

	NOTE !
	Below articles should be made respectively in the oil changing of hydraulic brakes. The reason is; oils of hydraulic brakes are different from gearboxes's one.

If the gear unit mounted vertical, the oil change must absolutely made from the expansion tank which is attached to gear unit. After 100 hours, first oil change must be made.



Changing the oil;

- Oil level plug, oil draining plug and ventilation plug must be removed.
- Both the oil is completely drained and the cleaning of gear unit must be made with proper solvent.
- The leakproofing elements on gear unit must be changed with original items.
- The oil draining plug must be put back to it's own place again.
- If the oil draining and level plug's gear part are damaged, instead of these, the new plug must be used.
- Before putting on the plugs, the sticky must be applied to the gear part like Loctite 242. If the aluminum washer is damaged, the new one must be used.
- The aluminum washer must be put lower and oil draining bolt must be bolted with proper moment.
- The oil according to mounting position must be filled from the vent hole with the proper draining device to the amount which is shown in catalogue. (could be filled from hole which is on the oil level). If the oil type is changed. Must be consulted to our firm.
- After the filling process, all plugs should be closed.
- 30 minutes after the oil filling, oil level must be controlled.

At high temperatures or at hard working conditions (high humidity, corrosive environment or high temperature fluctuations), the oil changing ranges must be reduced by half.

4.6 Oil Plugs Squeezing Torc Chart

Table 7: Oil Plugs Squeezing Torc Chart

Plug	Torc [Nm]
1/4"	7
3/8"	7
1/2"	12

4.7 Change of the Ventilation Plug

In excessive pollution situations, ventilation plug must be dismantled and got cleaned or with aluminum washer, the new ventilation plug must be mounted.

4.8 Change of the Oil Seal and Oil Cover

- The electric connection of motor drive unit must be cut and got into safety for mistakenly re-activation.
- At the time oil seal is changing, the sufficient amount of grease must be found between leakproofing lips and should be paid attention that the surface is not dirty and dusty.
- When the double seal is used, 3/2 of the part which remained between two seal must be filled with grease convenient to the oil type inside the gear unit.
- During the change of the oil seal the proper devices must be used for not to harm the body and shaft.
- During the change of the oil seal and oil filler cup, the original product must be used.

4.9 The Bearing Greases

- To the bearings of motorized gearboxes, greases should be used which are available at the grease table given by our company.
- Our company (PGR) recommends also replacing of grease while changing lubricant at the greased bearings.



4.10 General Overhaul

The gear unit must fully be dismantled and works written below have to be done respectively.

- All parts of the gear unit must be cleaned.
- The damage control must be done to all parts of the gear unit.
- The damaged parts must be changed with original part.
- All roller bearings must be changed.
- If there are, locks must be changed.
- All oil seals and nilos caps must be changed.

All plastic and elastomer parts of the motor coupling must be changed.

	<p>NOTE !</p> <p>The general revision should be made by the qualified personnel with considering the international laws and regulations in the plants which has the required equipments. We recommend that the general revision has to be made at the PGR service.</p>
--	---

4.11 The Maintenance of the Motor

Our firm recommends to change the grease in greased bearings.

Before the start of motor maintenance, the operator should closed the unit, must be sured that it is out of service and must taken all the measures against any accident or unexpected load.

- To prevent overheating, if there is, the dust coat on it must be cleaned.
- The bearings must be dismantled, cleaned and greased.
- By 1/3 of bearing, the grease must be used.
- The proper grease must be selected from the oil tables.
- Motor oil seals must be changed.

4.12 Temperature Measurement

The details of the ATEX temperature class or the maximum surface temperature are based on normal installation conditions. Even small changes to the installation conditions can have a significant effect on the temperature of the gear unit.

	<p>EXPLOSION !</p> <p>Explosion hazard: Failure to comply may cause severe, or even fatal injuries. On commissioning, a surface temperature measurement of the gear unit must be made under maximum load. (This does not apply to gear units which are labelled as temperature class T4 or a maximum surface temperature of 130°C in the last line of the type plate.)</p>
--	--

For the temperature measurement, a normal temperature measuring device is required, with a measurement range from 0°C to 130°C and a precision of at least ± 4°C and which enables the measurement of the surface temperature and the temperature of the air. Temperature measurement procedure:

1. Allow the gear unit to run at maximum speed under maximum load for approx. 4 hours.
2. Following warm-up, the temperature of the gear unit housing surface "T_{gm}" must be measured close to the temperature indication label .
3. Measure the temperature of the air "T_{um}" in the immediate vicinity of the gear unit.

	<p>EXPLOSION !</p> <p>Explosion hazard: Failure to comply may cause severe, or even fatal injuries. The gear unit must be shut down and PGR must be consulted if any of the following criteria do not apply.</p>
--	--



- The measured air temperature "T_{um}" is within the permissible range stated on the type plate;
- The measured temperature of the surface of the gear unit housing "T_{gm}" is below 121 °C and the temperature indication label has not turned black (see Figure 9).
- The measured temperature of the surface of the gear unit housing plus the difference between the highest permissible air temperature "T_u" stated on the type plate and the measured air temperature must be at least 15 °C lower than the maximum permissible surface temperature, i.e.:

ATEX labelling: II 2G Ex h IIC T4 Gb	:	$T_{gm} + T_u - T_{um} < 135\text{ °C} - 15\text{ °C}$
ATEX labelling: II 2D Ex h IIIC T120°C Db	:	$T_{gm} + T_u - T_{um} < T_{max} - 15\text{ °C}$
T_{gm} : Measured temperature of the surface of the gear unit housing in °C		
T_{um} : Measured air temperature in °C		
T_{max} : Maximum surface temperature according to gear unit type plate (ATEX labelling) in °C		
T_u : Upper value of the permissible ambient temperature range according to the type plate in °C		





EXPLOSION !

At normal working conditions, surface temperature should be controlled by initial operating.

The temperature must be measured under below conditions:

- Ambient temperature should not be higher than +40 °C.
- At full load, it should not be operated minimum 4 hour long continuously.
- There should not be potentially explosive atmosphere.

Generally entry parts of gearboxes (shows by crossing line) would be much more heating up compared to exit.

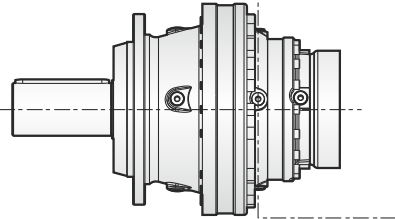

If negative brake is used, please measure temperatures of on-brake casing with their discs.

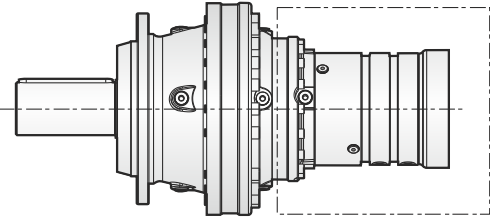

- Besides please control that there would not be any abnormal temperature at places which are close to channels,
- If temperature exceeds **130 °C**, please immediately stop machine and get in contact with PGR.

Figure 9: Temperature Sticker 2

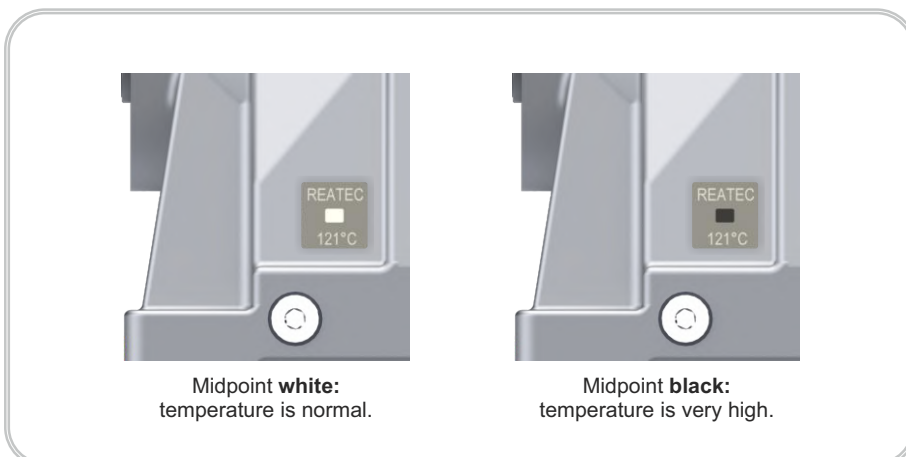



5.1 Mounting Positions

Install the gearbox at the projected moutage position. For the other moutage positions except this one, please consult to our Technical Service.

Figure 10: Mounting Positions

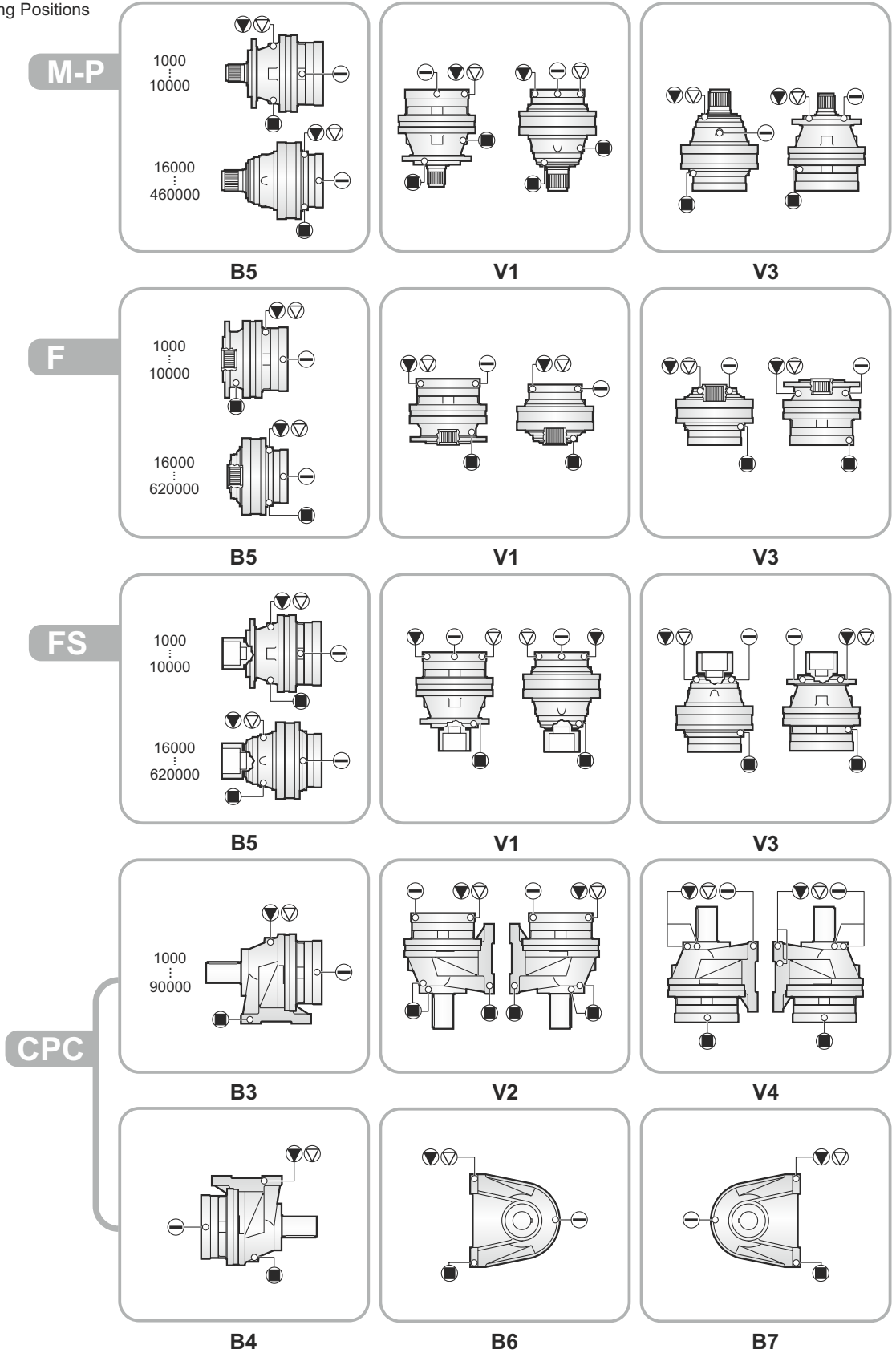

▼ Filling Plug

▽ Vent Plug

⊖ Oil Level Plug

● Drain Plug



M-P

1000
10000

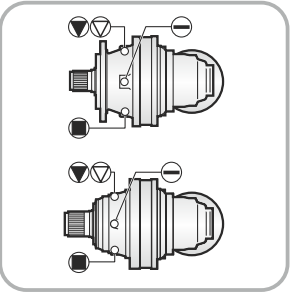
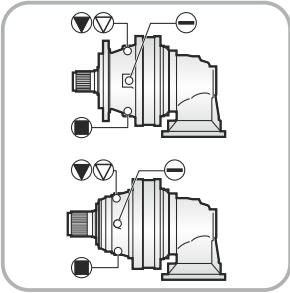
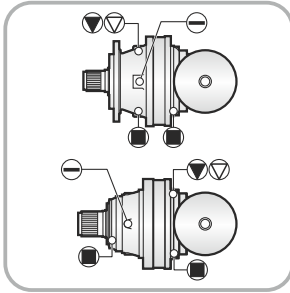
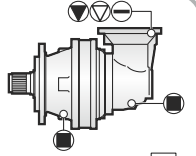

B51

B55

B53

B54

16000
460000

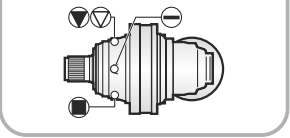
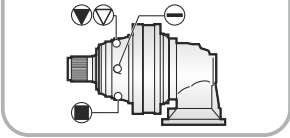
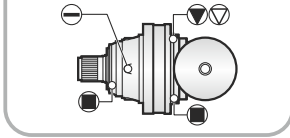
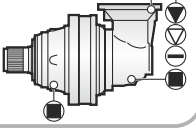

F

1000
10000

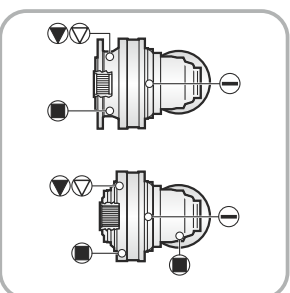
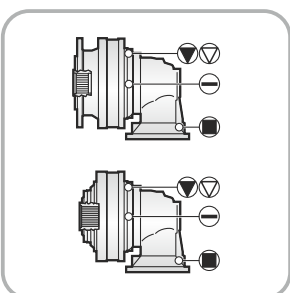
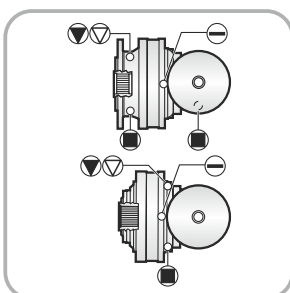
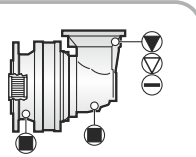

B51

B55

B53

B54

16000
620000

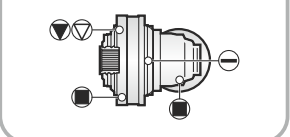
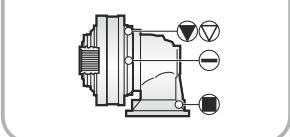
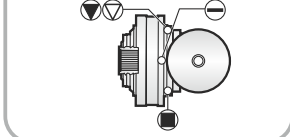
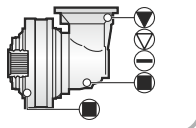

FS

1000
10000

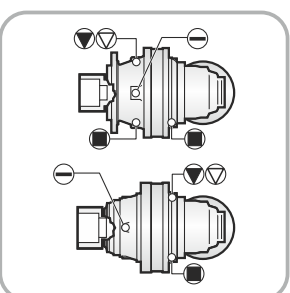
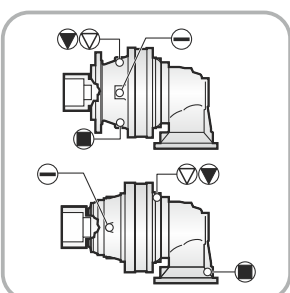
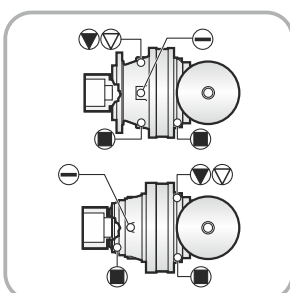
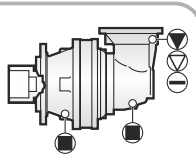

B51

B55

B53

B54

16000
620000

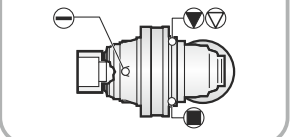
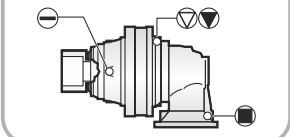
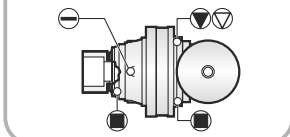
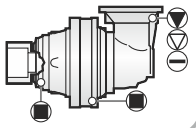

CPC

1000
90000

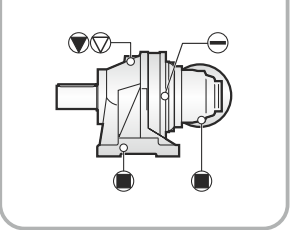
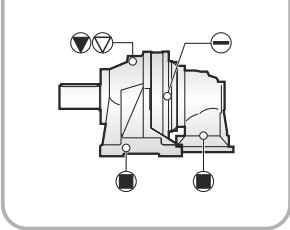
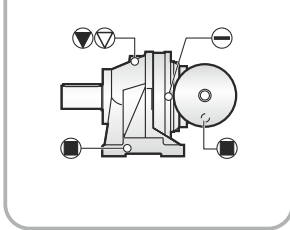
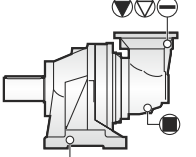

B56

B60

B58

B62

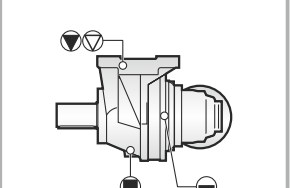
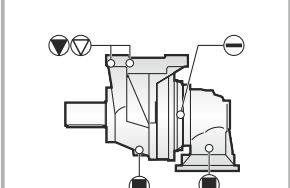
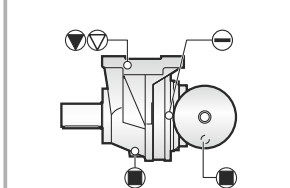
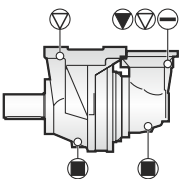

B57

B61

B59

B63

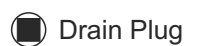

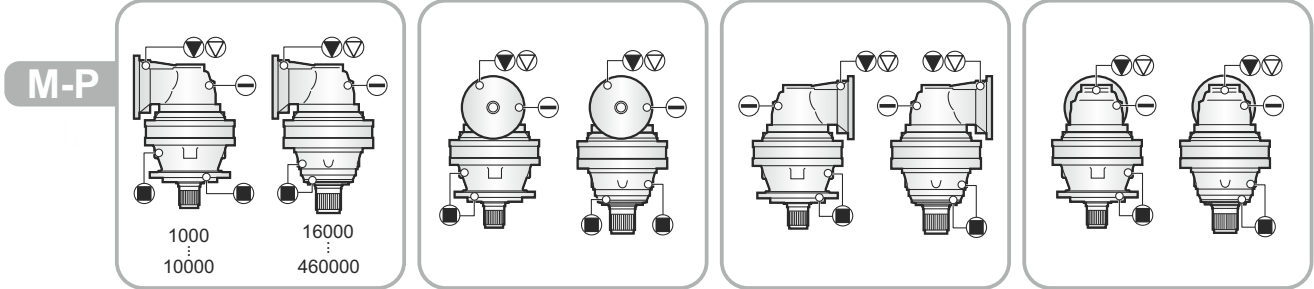

V15

V16

V17

V18

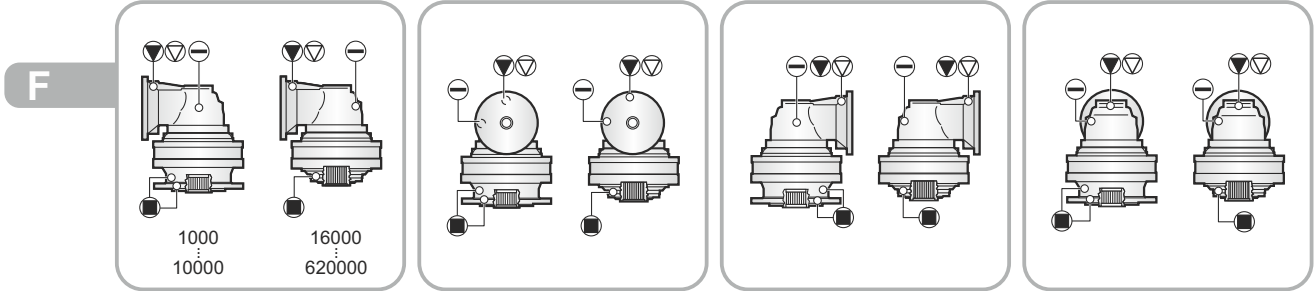

V15

V16

V17

V18

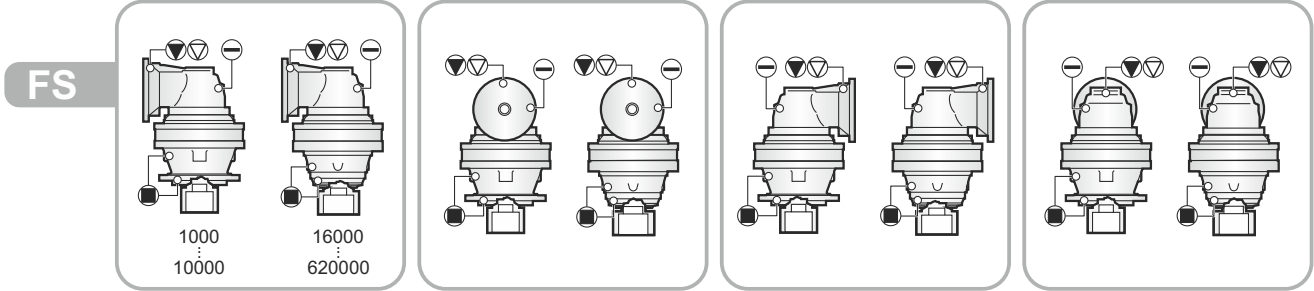

V15

V16

V17

V18

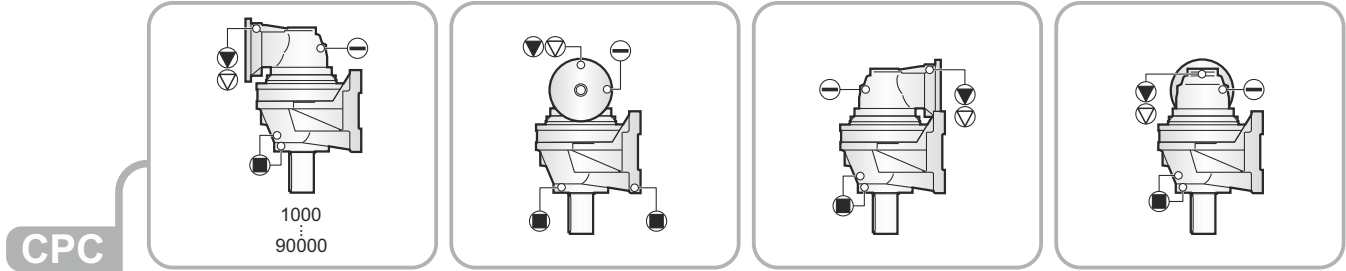

V53

V52

V54

V55

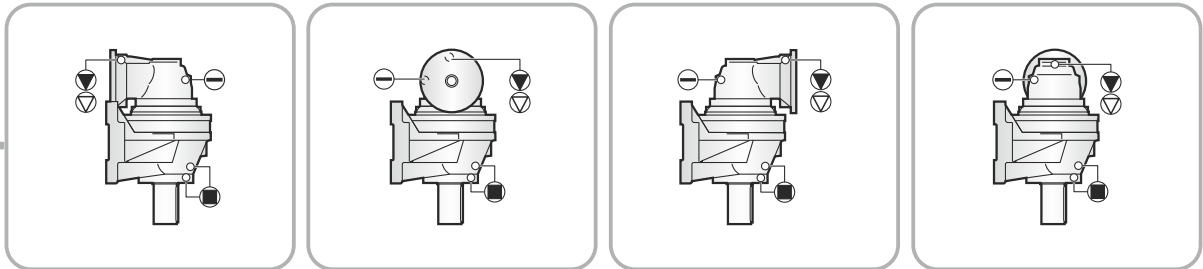

V49

V48

V50

V51



Filling Plug



Vent Plug



Oil Level Plug

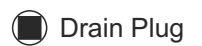

Drain Plug



M-P

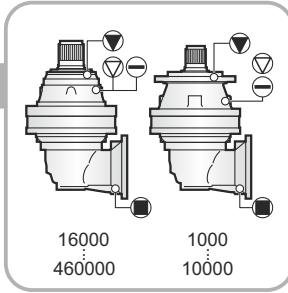

V35

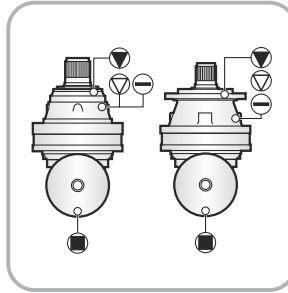

V36

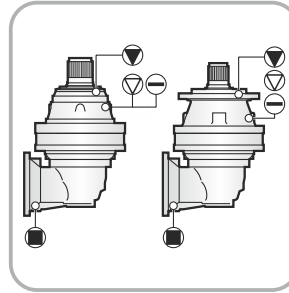

V37

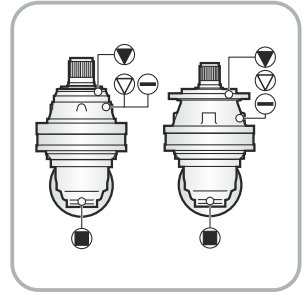

V38

F

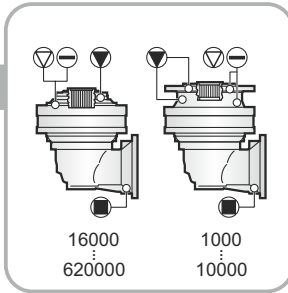

V35

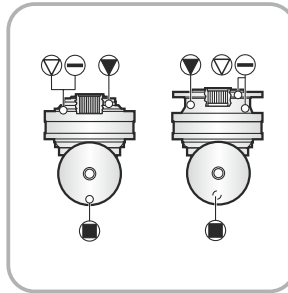

V36

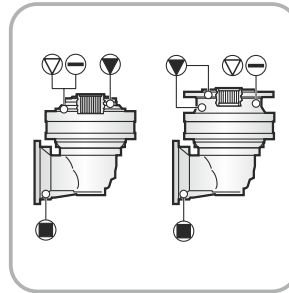

V37

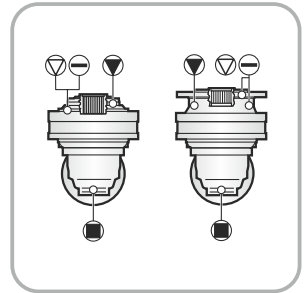

V38

FS

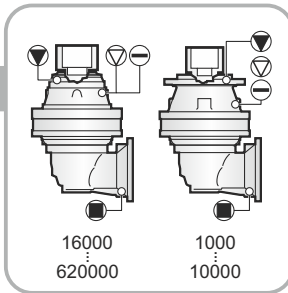

V35

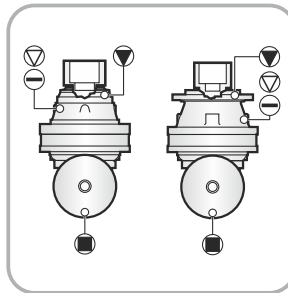

V36

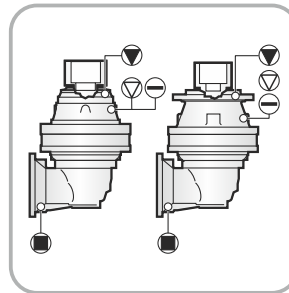

V37

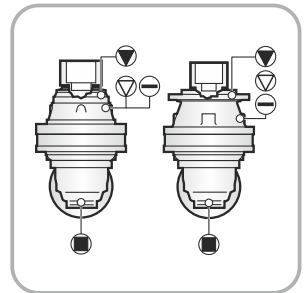

V38

CPC

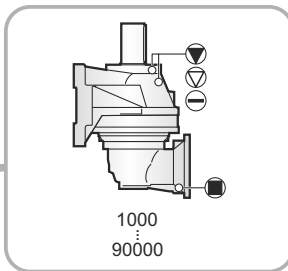

V42

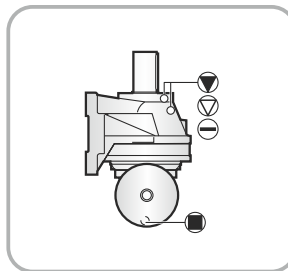

V40

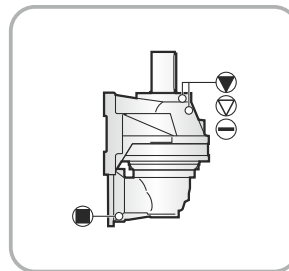

V41

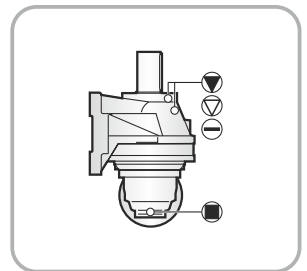

V43

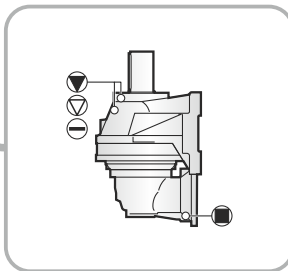

V46

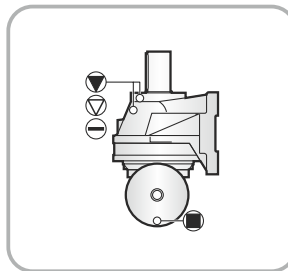

V44

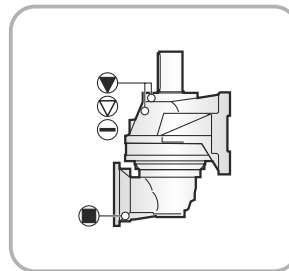

V45

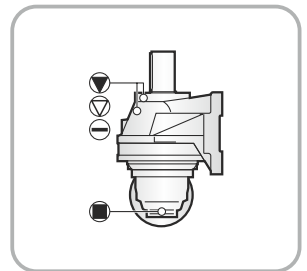

V47



Filling Plug



Vent Plug



Oil Level Plug



Drain Plug

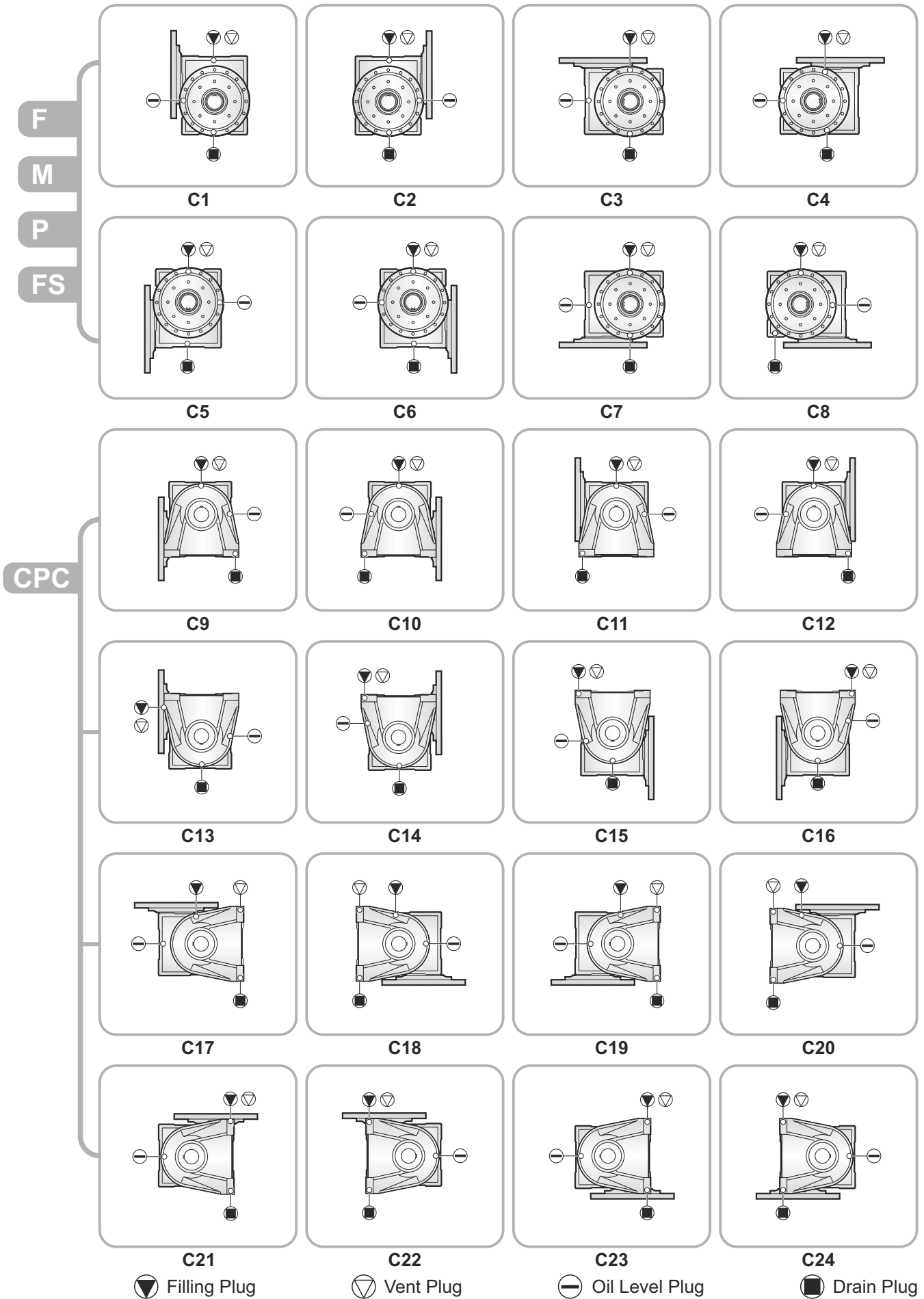

Filling Plug
 Vent Plug
 Oil Level Plug
 Drain Plug



6.1 Lubrication

PL/PLB series are lubricated with gear unit rinsing. ISO VG 220-viscosited and EP mixed mineral oil must be used. The oil types which could be purchased from the oil producers are given at the table below. During the operating, the exterior surface temperature must not be over 90°C. If the temperature exceeds this, must be contacted with PGR technical service.

For ensuring the smooth running of the gear unit, the correct lubricating is essential; therefore at the mounting stage the following situations must be controlled:

- In compliance with the mounting position stated at order, must be controlled that whether the plugs are inserted correctly in pursuant of given informations.
- If the gear unit is mounted horizontal, must be filled at half, regardless of it's linear or angular position. With dismantling of the plug which is at or over that area, the oil level must be eye-controlled.
- At the bevel gear unit orders (angular gear unit) with holding both pieces (only if they are same) at the intended mountage position, having the oil filling on the ground is recommended. Thus the filling will be getting fast and at the same time, as the time flows while passing from one division to another you would know that you have put the oil at the right quantity.
- If the gear unit is mounted vertical, by using of elbows and expansion tanks which sent with the gear unit, the oil must be filled from above. Using the expansion tank at these positions is recommended by PGR.

	NOTE !
	In continuously operating gear units because of the oil in it, it may be exposed to overheating. In these situations the use of lower viscosited oil is recommended by PGR.

6.2 Lubricant Fill Quantities

	NOTE!
	The lubricant quantities shown in the table are indicative, but should be verified during the filling operation, checking the level through the service plug.













	ATTENTION !
	If the input shaft is used, additional oil must be added. (see. Table 8)

Table 8: Additional Oil Table

Input Type	Horizontal (lt)	Vertical (lt)
ELC 28	0.2	0.3
ELC 42	0.2	0.3
EML 42	0.2	0.4
EML 1" 3/8 Z-6	0.2	0.4
EM 65	0.5	1.0
EM 1" 3/8 Z-6	0.5	1.0
EP 65	0.7	1.4
ET 90	1.9	3.8











Table 9: Lubricant Fill Quantities (PL - M / P / F / FS)

M	B5	V1 	P	B5	V1 	F	B5	V1 	FS	B5	V1 
		V3 			V3 			V3 			V3 
PL 1001	0.50	0.90	PL 1001	0.60	1.00	PL 1001	0.50	0.90	PL 1001	0.50	0.90
PL 1002	0.70	1.20	PL 1002	0.80	1.50	PL 1002	0.70	1.20	PL 1002	0.70	1.20
PL 1003	1.00	1.70	PL 1003	1.00	1.90	PL 1003	1.00	1.70	PL 1003	1.00	1.70
PL 1004	1.30	2.20	PL 1004	1.20	2.30	PL 1004	1.30	2.20	PL 1004	1.30	2.20
PL 1601	0.50	1.00	PL 1601	0.60	1.10	PL 1601	0.50	1.00	PL 1601	0.50	1.00
PL 1602	0.70	1.30	PL 1602	0.80	1.50	PL 1602	0.70	1.30	PL 1602	0.70	1.30
PL 1603	1.00	1.80	PL 1603	1.10	1.90	PL 1603	1.00	1.80	PL 1603	1.00	1.80
PL 1604	1.30	2.20	PL 1604	1.40	2.40	PL 1604	1.30	2.20	PL 1604	1.30	2.20
PL 2501	1.10	1.90	PL 2501	1.30	2.30	PL 2501	0.90	1.50	PL 2501	1.10	1.90
PL 2502	1.20	2.30	PL 2502	1.40	2.70	PL 2502	1.00	1.90	PL 2502	1.30	2.30
PL 2503	1.60	2.80	PL 2503	1.70	3.10	PL 2503	1.20	2.30	PL 2503	1.60	2.80
PL 2504	1.80	3.20	PL 2504	1.90	3.60	PL 2504	1.40	2.70	PL 2504	1.80	3.20
PL 5001	1.10	1.90	PL 5001	1.20	2.10	PL 5001	0.80	1.40	PL 5001	1.10	1.90
PL 5002	1.40	2.30	PL 5002	1.50	2.60	PL 5002	1.10	1.90	PL 5002	1.40	2.30
PL 5003	1.60	2.70	PL 5003	1.70	3.00	PL 5003	1.30	2.30	PL 5003	1.60	2.70
PL 5004	1.80	3.10	PL 5004	1.90	3.50	PL 5004	1.60	2.70	PL 5004	1.80	3.10
PL 7001	-	-	PL 7001	2.00	3.50	PL 7001	1.70	3.00	PL 7001	2.00	3.50
PL 7002	-	-	PL 7002	2.40	4.40	PL 7002	2.10	3.80	PL 7002	2.40	4.40
PL 7003	-	-	PL 7003	2.70	4.80	PL 7003	2.40	4.30	PL 7003	2.70	4.80
PL 7004	-	-	PL 7004	2.90	5.20	PL 7004	2.60	4.70	PL 7004	2.90	5.20
PL 10001	2.90	5.30	PL 10001	-	-	PL 10001	1.70	3.10	PL 10001	2.90	5.30
PL 10002	3.20	5.90	PL 10002	-	-	PL 10002	2.10	3.90	PL 10002	3.20	5.90
PL 10003	3.50	6.50	PL 10003	-	-	PL 10003	2.40	4.40	PL 10003	3.50	6.50
PL 10004	3.70	6.90	PL 10004	-	-	PL 10004	2.60	4.80	PL 10004	3.70	6.90
PL 16001	3.10	5.80	PL 16001	3.60	6.70	PL 16001	2.10	3.80	PL 16001	3.10	5.80
PL 16002	3.40	6.30	PL 16002	3.90	7.30	PL 16002	2.60	4.40	PL 16002	3.40	6.30
PL 16003	3.80	6.80	PL 16003	4.20	7.90	PL 16003	2.80	5.00	PL 16003	3.80	6.80
PL 16004	4.00	7.30	PL 16004	4.40	8.30	PL 16004	3.00	5.40	PL 16004	4.00	7.30
PL 18002	4.00	7.30	PL 18002	4.60	8.50	PL 18002	3.10	5.60	PL 18002	4.00	7.30
PL 18003	4.40	8.20	PL 18003	5.00	9.30	PL 18003	3.60	6.40	PL 18003	4.40	8.20
PL 18004	4.80	8.60	PL 18004	5.30	9.70	PL 18004	3.90	6.80	PL 18004	4.80	8.60
PL 25001	7.60	14.20				PL 25001	5.90	10.70	PL 25001	5.70	10.50
PL 25002	6.50	12.20				PL 25002	4.50	8.20	PL 25002	4.60	8.40
PL 25003	7.00	12.20				PL 25003	5.40	9.70	PL 25003	5.00	9.20
PL 25004	7.20	13.40				PL 25004	5.60	10.10	PL 25004	5.20	9.60
PL 30002	7.50	13.90				PL 30002	5.60	10.40	PL 30002	5.20	9.80
PL 30003	7.70	14.40				PL 30003	6.00	11.10	PL 30003	5.60	10.60
PL 30004	8.00	14.90				PL 30004	6.40	11.60	PL 30004	5.80	11.10
PL 35001	7.50	13.70				PL 35001	5.40	9.90	PL 35001	5.10	9.20
PL 35002	7.30	13.30				PL 35002	5.20	9.60	PL 35002	5.00	9.00
PL 35003	7.60	14.00				PL 35003	5.60	10.30	PL 35003	5.60	10.10
PL 35004	7.90	14.50				PL 35004	5.90	10.80	PL 35004	5.70	10.30
PL 50001	10.30	19.10				PL 50001	8.30	15.50	PL 50001	8.30	15.50
PL 50002	10.10	18.80				PL 50002	8.20	15.40	PL 50002	8.20	15.40
PL 50003	11.50	18.70				PL 50003	8.60	16.10	PL 50003	8.60	16.10
PL 50004	10.80	20.10				PL 50004	8.90	16.70	PL 50004	8.90	16.70
PL 65001	-	-				PL 65001	-	-	PL 65001	-	-
PL 65002	14.00	26.10				PL 65002	12.40	23.50	PL 65002	12.40	23.50
PL 65003	13.00	23.90				PL 65003	11.70	22.00	PL 65003	11.70	22.00
PL 65004	13.30	24.60				PL 65004	11.80	22.40	PL 65004	11.80	22.40
PL 90001	-	-				PL 90001	-	-	PL 90001	-	-
PL 90002	22	41				PL 90002	18	32	PL 90002	18	32
PL 90003	20	37				PL 90003	16	29	PL 90003	16	29
PL 90004	20	37				PL 90004	17	30	PL 90004	17	30

NOTE: For the additional oil table see page 45.









Table 10: Lubricant Fill Quantities (PL - M / F / FS)

M	B5	V1  V3	F	B5	V1  V3	FS	B5	V1  V3
								
PL 130001	13.5	-	PL 130001	14.3	-	PL 130001	14.3	-
PL 130002	14.9	29.8	PL 130002	15.7	31.4	PL 130002	15.7	31.4
PL 130003	16.1	32.2	PL 130003	16.9	33.8	PL 130003	16.9	33.8
PL 130004	16.6	33.2	PL 130004	17.4	34.8	PL 130004	17.4	34.8
PL 130005	16.9	33.8	PL 130005	17.7	35.4	PL 130005	17.7	35.4
PL 170001	14.5	-	PL 170001	14.5	29	PL 170001	14.5	29
PL 170002	16.9	33.8	PL 170002	16.9	33.8	PL 170002	16.9	33.8
PL 170003	18.3	36.6	PL 170003	18.3	36.6	PL 170003	18.3	36.6
PL 170004	18.8	37.6	PL 170004	18.8	37.6	PL 170004	18.8	37.6
PL 170005	19.1	38.2	PL 170005	19.1	38.2	PL 170005	19.1	38.2
PL 220001	21	42	PL 220001	21	42	PL 220001	21	42
PL 220002	23.4	46.8	PL 220002	23.4	46.8	PL 220002	23.4	46.8
PL 220003	24.8	49.6	PL 220003	24.8	49.6	PL 220003	24.8	49.6
PL 220004	25.3	50.6	PL 220004	25.3	50.6	PL 220004	25.3	50.6
PL 220005	25.6	51.2	PL 220005	25.6	51.2	PL 220005	25.6	51.2
PL 250001	20	40	PL 250001	20	40	PL 250001	20	40
PL 250002	25.2	50.4	PL 250002	25.2	50.4	PL 250002	25.2	50.4
PL 250003	26.6	53.2	PL 250003	26.6	53.2	PL 250003	26.6	53.2
PL 250004	27.5	55	PL 250004	27.5	55	PL 250004	27.5	55
PL 250005	27.9	55.8	PL 250005	27.9	55.8	PL 250005	27.9	55.8
PL 300001	42	84	PL 300001	42	84	PL 300001	42	84
PL 300002	46.5	93	PL 300002	46.5	93	PL 300002	46.5	93
PL 300003	47.9	95.8	PL 300003	47.9	95.8	PL 300003	47.9	95.8
PL 300004	48.7	97.4	PL 300004	48.7	97.4	PL 300004	48.7	97.4
PL 300005	49.1	98.2	PL 300005	49.1	98.2	PL 300005	49.1	98.2
PL 380001	44	88	PL 380001	44	88	PL 380001	44	88
PL 380002	49	98	PL 380002	49	98	PL 380002	49	98
PL 380003	50.4	100.8	PL 380003	50.4	100.8	PL 380003	50.4	100.8
PL 380004	51.3	102.6	PL 380004	51.3	102.6	PL 380004	51.3	102.6
PL 380005	51.7	103.4	PL 380005	51.7	103.4	PL 380005	51.7	103.4
PL 460001	44	88	PL 460001	44	88	PL 460001	44	88
PL 460002	50	100	PL 460002	50	100	PL 460002	50	100
PL 460003	52.4	104.8	PL 460003	52.4	104.8	PL 460003	52.4	104.8
PL 460004	53.8	107.6	PL 460004	53.8	107.6	PL 460004	53.8	107.6
PL 460005	54.3	108.6	PL 460005	54.3	108.6	PL 460005	54.3	108.6
PL 550001	70	140	PL 550001	70	140	PL 550001	70	140
PL 550002	80	160	PL 550002	80	160	PL 550002	80	160
PL 550003	82.4	164.8	PL 550003	82.4	164.8	PL 550003	82.4	164.8
PL 550004	83.8	167.6	PL 550004	83.8	167.6	PL 550004	83.8	167.6
PL 550005	84.3	168.6	PL 550005	84.3	168.6	PL 550005	84.3	168.6
PL 620001	67	134	PL 620001	67	134	PL 620001	67	134
PL 620002	77	154	PL 620002	77	154	PL 620002	77	154
PL 620003	79.4	158.8	PL 620003	79.4	158.8	PL 620003	79.4	158.8
PL 620004	80.8	161.6	PL 620004	80.8	161.6	PL 620004	80.8	161.6
PL 620005	81.3	162.6	PL 620005	81.3	162.6	PL 620005	81.3	162.6

NOTE: For the additional oil table see page 45.



Table 11: Lubricant Fill Quantities (PL - CPC)

CPC	B3 	B4 	B6  B7 	V2  V4 
PL 1001	1.30	0.70	1.00	1.80
PL 1002	1.50	0.80	1.20	2.10
PL 1003	1.80	1.10	1.50	2.50
PL 1004	2.10	1.30	1.70	3.00
PL 1601	1.40	0.70	1.00	1.80
PL 1602	1.50	0.90	1.20	2.10
PL 1603	1.80	1.20	1.50	2.60
PL 1604	2.10	1.40	1.70	3.10
PL 2501	3.60	1.60	2.60	4.90
PL 2502	3.90	1.90	2.90	5.30
PL 2503	4.10	2.10	3.10	5.80
PL 2504	4.30	2.40	3.40	6.20
PL 5001	3.50	1.50	2.50	4.70
PL 5002	3.80	1.80	2.80	5.20
PL 5003	4.10	2.10	3.10	5.70
PL 5004	4.30	2.30	3.30	6.10
PL 7001	7.40	2.80	5.20	9.70
PL 7002	7.80	3.30	5.70	10.60
PL 7003	8.00	3.40	5.80	10.80
PL 7004	8.30	3.70	6.10	11.40
PL 10001	9.50	3.70	6.70	12.70
PL 10002	9.90	4.10	7.10	13.30
PL 10003	10.20	4.40	7.40	13.90
PL 10004	10.40	4.60	7.60	14.30
PL 16001	9.70	3.90	6.80	12.90
PL 16002	10.00	4.20	7.10	13.60
PL 16003	10.30	4.50	7.40	14.10
PL 16004	10.60	4.80	7.70	14.50
PL 18002	10.80	4.70	7.90	14.70
PL 18003	11.20	5.20	8.40	15.50
PL 18004	11.50	5.50	8.60	16.00
PL 25001	7.60	7.60	7.60	14.20
PL 25002	6.50	6.50	6.50	12.20
PL 25003	7.00	7.00	7.00	13.00
PL 25004	7.20	7.20	7.20	13.40
PL 30002	7.50	7.50	7.50	13.90
PL 30003	7.70	7.70	7.70	14.40
PL 30004	8.00	8.00	8.00	14.90
PL 35001	7.50	7.50	7.50	13.70
PL 35002	7.30	7.30	7.30	13.30
PL 35003	7.60	7.60	7.60	14.00
PL 35004	7.90	7.90	7.90	14.50
PL 50001	10.30	10.30	10.30	19.10
PL 50002	10.10	10.10	10.10	18.80
PL 50003	10.10	10.10	10.10	18.70
PL 50004	10.80	10.80	10.80	20.10
PL 65001	-	-	-	-
PL 65002	14.00	14.00	14.00	26.10
PL 65003	13.00	13.00	13.00	23.90
PL 65004	13.30	13.30	13.30	24.60
PL 90001	-	-	-	-
PL 90002	22	22	22	41
PL 90003	20	20	20	37
PL 90004	20	20	20	37

NOTE: For the additional oil table see page 45.















Table 12: Lubricant Fill Quantities (PLB - M)

M	B51	B55	B53	B54	V15	V16	V17	V18	V35	V36	V37	V38
PLB 1002	1.90	1.20	1.40	1.20	1.60	1.60	1.60	1.60	1.90	1.90	1.90	1.90
PLB 1003	2.20	1.40	1.60	1.40	1.90	1.90	1.90	1.90	2.20	2.20	2.20	2.20
PLB 1004	2.70	1.70	1.90	1.70	2.40	2.40	2.40	2.40	2.70	2.70	2.70	2.70
PLB 1602	2.00	1.20	1.40	1.20	1.70	1.70	1.70	1.70	2.00	2.00	2.00	2.00
PLB 1603	2.30	1.40	1.60	1.40	2.00	2.00	2.00	2.00	2.30	2.30	2.30	2.30
PLB 1604	2.80	1.70	1.90	1.70	2.50	2.50	2.50	2.50	2.80	2.80	2.80	2.80
PLB 2502	2.90	1.80	2.00	1.80	2.60	2.60	2.60	2.60	2.90	2.90	2.90	2.90
PLB 2503	3.30	1.90	2.10	1.90	3.00	3.00	3.00	3.00	3.30	3.30	3.30	3.30
PLB 2504	3.80	2.30	2.50	2.30	3.50	3.50	3.50	3.50	3.80	3.80	3.80	3.80
PLB 5002	5.20	2.90	3.30	2.90	3.70	3.70	3.70	3.70	5.20	5.20	5.20	5.20
PLB 5003	3.30	2.10	2.30	2.10	3.00	3.00	3.00	3.00	3.30	3.30	3.30	3.30
PLB 5004	3.70	2.30	2.50	2.30	3.40	3.40	3.40	3.40	3.70	3.70	3.70	3.70
PLB 7002	-	-	-	-	-	-	-	-	-	-	-	-
PLB 7003	-	-	-	-	-	-	-	-	-	-	-	-
PLB 7004	-	-	-	-	-	-	-	-	-	-	-	-
PLB 10002	8.60	4.70	5.10	4.70	7.10	7.10	7.10	7.10	8.60	8.60	8.60	8.60
PLB 10003	9.20	5.00	5.40	5.00	7.70	7.70	7.70	7.70	9.20	9.20	9.20	9.20
PLB 10004	7.50	4.20	4.40	4.20	7.20	7.20	7.20	7.20	7.50	7.50	7.50	7.50
PLB 16002	9.10	4.90	5.30	4.90	7.60	7.60	7.60	7.60	9.10	9.10	9.10	9.10
PLB 16003	9.60	5.20	5.60	5.20	8.10	8.10	8.10	8.10	9.60	9.60	9.60	9.60
PLB 16004	7.80	4.50	4.70	4.50	7.50	7.50	7.50	7.50	7.80	7.80	7.80	7.80
PLB 18002	15.60	8.60	9.00	8.60	13.30	13.30	13.30	13.30	15.60	15.60	15.60	15.60
PLB 18003	10.60	5.80	6.20	5.80	9.10	9.10	9.10	9.10	10.60	10.60	10.60	10.60
PLB 18004	11.50	6.20	6.60	6.20	10.00	10.00	10.00	10.00	11.50	11.50	11.50	11.50
PLB 25002	18.50	10.00	10.20	10.00	15.60	15.60	15.60	15.60	18.50	18.50	18.50	18.50
PLB 25003	15.50	8.30	8.70	8.30	14.00	14.00	14.00	14.00	15.50	15.50	15.50	15.50
PLB 25004	15.50	8.80	9.20	8.80	14.00	14.00	14.00	14.00	15.50	15.50	15.50	15.50
PLB 30003	23.70	12.60	12.80	12.60	21.40	21.40	21.40	21.40	23.70	23.70	23.70	23.70
PLB 30004	17.70	9.50	9.90	9.50	16.20	16.20	16.20	16.20	17.70	17.70	17.70	17.70
PLB 35002	17.70	9.70	9.90	9.70	14.80	14.80	14.80	14.80	17.70	17.70	17.70	17.70
PLB 35003	23.40	12.70	13.10	12.70	21.10	21.10	21.10	21.10	23.40	23.40	23.40	23.40
PLB 35004	17.30	9.40	9.80	9.40	15.80	15.80	15.80	15.80	17.30	17.30	17.30	17.30
PLB 50002	28.30	15.40	15.60	15.40	25.90	25.90	25.90	25.90	28.30	28.30	28.30	28.30
PLB 50003	22.10	11.90	12.30	11.90	20.60	20.60	20.60	20.60	22.10	22.10	22.10	22.10
PLB 50004	22.00	13.30	13.70	13.30	20.50	20.50	20.50	20.50	22.00	22.00	22.00	22.00
PLB 65003	30.20	16.10	16.30	16.10	27.30	27.30	27.30	27.30	30.20	30.20	30.20	30.20
PLB 65004	27.20	14.80	15.20	14.80	25.70	25.70	25.70	25.70	27.20	27.20	27.20	27.20
PLB 90003	44.50	22.30	22.50	22.30	41.60	41.60	41.60	41.60	44.50	44.50	44.50	44.50
PLB 90004	40.30	21.80	22.20	21.80	38.80	38.80	38.80	38.80	40.30	40.30	40.30	40.30
PLB 130003	35.80	17.90	*	17.90	*	*	*	*	35.80	35.80	35.80	35.80
PLB 130004	38.20	19.10	*	19.10	*	*	*	*	38.20	38.20	38.20	38.20
PLB 130005	37.20	18.60	*	18.60	*	*	*	*	37.20	37.20	37.20	37.20
PLB 170003	39.80	19.90	*	19.90	*	*	*	*	39.80	39.80	39.80	39.80
PLB 170004	42.60	21.30	*	21.30	*	*	*	*	42.60	42.60	42.60	42.60
PLB 170005	41.60	20.80	*	20.80	*	*	*	*	41.60	41.60	41.60	41.60
PLB 220003	52.80	26.40	*	26.40	*	*	*	*	52.80	52.80	52.80	52.80
PLB 220004	55.60	27.80	*	27.80	*	*	*	*	55.60	55.60	55.60	55.60
PLB 220005	54.60	27.30	*	27.30	*	*	*	*	54.60	54.60	54.60	54.60
PLB 250004	59.20	29.60	*	29.60	*	*	*	*	59.20	59.20	59.20	59.20
PLB 250005	59.00	29.50	*	29.50	*	*	*	*	59.00	59.00	59.00	59.00
PLB 300004	101.80	50.90	*	50.90	*	*	*	*	101.80	101.80	101.80	101.80
PLB 300005	101.40	50.70	*	50.70	*	*	*	*	101.40	101.40	101.40	101.40
PLB 380005	108.60	54.30	*	54.30	*	*	*	*	108.60	108.60	108.60	108.60
PLB 460005	113.60	56.80	*	56.80	*	*	*	*	113.60	113.60	113.60	113.60
PLB 550005	173.60	86.80	*	86.80	*	*	*	*	173.60	173.60	173.60	173.60
PLB 620005	167.60	83.80	*	83.80	*	*	*	*	167.60	167.60	167.60	167.60

NOTE: For the additional oil table see page 45. * Please contact PGR!



Table 13: Lubricant Fill Quantities (PLB - P)

P												
PLB 1002	2.00	1.30	1.50	1.30	1.70	1.70	1.70	1.70	2.00	2.00	2.00	2.00
PLB 1003	2.50	1.50	1.70	1.50	2.20	2.20	2.20	2.20	2.50	2.50	2.50	2.50
PLB 1004	2.90	1.70	1.90	1.70	2.60	2.60	2.60	2.60	2.90	2.90	2.90	2.90
PLB 1602	2.10	1.30	1.50	1.30	1.80	1.80	1.80	1.80	2.10	2.10	2.10	2.10
PLB 1603	2.50	1.50	1.70	1.50	2.20	2.20	2.20	2.20	2.50	2.50	2.50	2.50
PLB 1604	2.90	1.80	2.00	1.80	2.60	2.60	2.60	2.60	2.90	2.90	2.90	2.90
PLB 2502	3.30	2.00	2.20	2.00	3.00	3.00	3.00	3.00	3.30	3.30	3.30	3.30
PLB 2503	3.70	2.10	2.30	2.10	3.40	3.40	3.40	3.40	3.70	3.70	3.70	3.70
PLB 2504	4.10	2.40	2.60	2.40	3.80	3.80	3.80	3.80	4.10	4.10	4.10	4.10
PLB 5002	5.40	3.00	3.40	3.00	3.90	3.90	3.90	3.90	5.40	5.40	5.40	5.40
PLB 5003	3.60	2.20	2.40	2.20	3.30	3.30	3.30	3.30	3.60	3.60	3.60	3.60
PLB 5004	4.00	2.40	2.60	2.40	3.70	3.70	3.70	3.70	4.00	4.00	4.00	4.00
PLB 7002	6.80	3.80	4.20	3.80	5.30	5.30	5.30	5.30	6.80	6.80	6.80	6.80
PLB 7003	5.40	3.10	3.30	3.10	5.10	5.10	5.10	5.10	5.40	5.40	5.40	5.40
PLB 7004	5.80	3.40	3.60	3.40	5.50	5.50	5.50	5.50	5.80	5.80	5.80	5.80
PLB 10002	-	-	-	-	-	-	-	-	-	-	-	-
PLB 10003	-	-	-	-	-	-	-	-	-	-	-	-
PLB 10004	-	-	-	-	-	-	-	-	-	-	-	-
PLB 16002	10.00	5.40	5.80	5.40	8.50	8.50	8.50	8.50	10.00	10.00	10.00	10.00
PLB 16003	10.60	5.70	6.10	5.70	9.10	9.10	9.10	9.10	10.60	10.60	10.60	10.60
PLB 16004	8.90	4.90	5.10	4.90	8.60	8.60	8.60	8.60	8.90	8.90	8.90	8.90
PLB 18002	16.60	9.20	9.60	9.20	14.30	14.30	14.30	14.30	16.60	16.60	16.60	16.60
PLB 18003	11.80	6.40	6.80	6.40	10.30	10.30	10.30	10.30	11.80	11.80	11.80	11.80
PLB 18004	12.60	6.80	7.20	6.80	11.10	11.10	11.10	11.10	12.60	12.60	12.60	12.60

NOTE: For the additional oil table see page 45.



Table 14: Lubricant Fill Quantities (PLB - F)

F	B51	B55	B53	B54	V15	V16	V17	V18	V35	V36	V37	V38
PLB 1002	1.90	1.20	1.40	1.20	1.60	1.60	1.60	1.60	1.90	1.90	1.90	1.90
PLB 1003	2.20	1.40	1.60	1.40	1.90	1.90	1.90	1.90	2.20	2.20	2.20	2.20
PLB 1004	2.70	1.70	1.90	1.70	2.40	2.40	2.40	2.40	2.70	2.70	2.70	2.70
PLB 1602	2.00	1.20	1.40	1.20	1.70	1.70	1.70	1.70	2.00	2.00	2.00	2.00
PLB 1603	2.30	1.40	1.60	1.40	2.00	2.00	2.00	2.00	2.30	2.30	2.30	2.30
PLB 1604	2.80	1.70	1.90	1.70	2.50	2.50	2.50	2.50	2.80	2.80	2.80	2.80
PLB 2502	2.50	1.60	1.80	1.60	2.20	2.20	2.20	2.20	2.50	2.50	2.50	2.50
PLB 2503	2.90	1.90	2.10	1.90	2.60	2.60	2.60	2.60	2.90	2.90	2.90	2.90
PLB 2504	3.30	1.90	2.10	1.90	3.00	3.00	3.00	3.00	3.30	3.30	3.30	3.30
PLB 5002	4.70	2.60	3.00	2.60	3.20	3.20	3.20	3.20	4.70	4.70	4.70	4.70
PLB 5003	2.90	1.80	2.00	1.80	2.60	2.60	2.60	2.60	2.90	2.90	2.90	2.90
PLB 5004	3.30	2.00	2.20	2.00	3.00	3.00	3.00	3.00	3.30	3.30	3.30	3.30
PLB 7002	6.30	3.50	3.90	3.50	4.80	4.80	4.80	4.80	6.30	6.30	6.30	6.30
PLB 7003	4.80	2.80	3.00	2.80	4.50	4.50	4.50	4.50	4.80	4.80	4.80	4.80
PLB 7004	5.30	3.10	3.30	3.10	5.00	5.00	5.00	5.00	5.30	5.30	5.30	5.30
PLB 10002	6.40	3.50	3.90	3.50	4.90	4.90	4.90	4.90	6.40	6.40	6.40	6.40
PLB 10003	7.20	3.90	4.30	3.90	5.70	5.70	5.70	5.70	7.20	7.20	7.20	7.20
PLB 10004	5.40	3.10	3.30	3.10	5.10	5.10	5.10	5.10	5.40	5.40	5.40	5.40
PLB 16002	7.10	3.90	4.30	3.90	5.60	5.60	5.60	5.60	7.10	7.10	7.10	7.10
PLB 16003	7.70	4.40	4.80	4.40	6.20	6.20	6.20	6.20	7.70	7.70	7.70	7.70
PLB 16004	6.00	3.50	3.70	3.50	5.70	5.70	5.70	5.70	6.00	6.00	6.00	6.00
PLB 18002	13.70	7.70	8.10	7.70	11.40	11.40	11.40	11.40	13.70	13.70	13.70	13.70
PLB 18003	8.90	4.90	5.30	4.90	7.40	7.40	7.40	7.40	8.90	8.90	8.90	8.90
PLB 18004	9.70	5.40	5.80	5.40	8.20	8.20	8.20	8.20	9.70	9.70	9.70	9.70
PLB 25002	14.90	8.10	8.30	8.10	12.00	12.00	12.00	12.00	14.90	14.90	14.90	14.90
PLB 25003	11.50	6.30	6.70	6.30	10.00	10.00	10.00	10.00	11.50	11.50	11.50	11.50
PLB 25004	13.00	7.20	7.60	7.20	12.50	12.50	12.50	12.50	13.00	13.00	13.00	13.00
PLB 30003	20.40	11.20	11.40	11.20	18.10	18.10	18.10	18.10	20.40	20.40	20.40	20.40
PLB 30004	14.40	7.80	8.20	7.80	12.90	12.90	12.90	12.90	14.40	14.40	14.40	14.40
PLB 35002	14.50	8.00	8.20	8.00	11.60	11.60	11.60	11.60	14.50	14.50	14.50	14.50
PLB 35003	19.50	10.70	11.10	10.70	17.20	17.20	17.20	17.20	19.50	19.50	19.50	19.50
PLB 35004	13.60	7.40	7.80	7.40	12.10	12.10	12.10	12.10	13.60	13.60	13.60	13.60
PLB 50002	24.80	13.40	13.60	13.40	22.40	22.40	22.40	22.40	24.80	24.80	24.80	24.80
PLB 50003	18.70	10.00	10.40	10.00	17.20	17.20	17.20	17.20	18.70	18.70	18.70	18.70
PLB 50004	19.40	10.40	10.70	10.40	17.90	17.90	17.90	17.90	19.40	19.40	19.40	19.40
PLB 65003	27.90	14.90	15.10	14.90	25.00	25.00	25.00	25.00	27.90	27.90	27.90	27.90
PLB 65004	25.30	13.50	13.90	13.50	23.80	23.80	23.80	23.80	25.30	25.30	25.30	25.30
PLB 90003	35.00	18.30	18.50	18.30	32.10	32.10	32.10	32.10	35.00	35.00	35.00	35.00
PLB 90004	32.30	17.80	18.20	17.80	30.80	30.80	30.80	30.80	32.30	32.30	32.30	32.30
PLB 130003	37.40	18.70	*	18.70	*	*	*	*	37.40	37.40	37.40	37.40
PLB 130004	39.80	19.90	*	19.90	*	*	*	*	39.80	39.80	39.80	39.80
PLB 130005	38.80	19.40	*	19.40	*	*	*	*	38.80	38.80	38.80	38.80
PLB 170003	39.80	19.90	*	19.90	*	*	*	*	39.80	39.80	39.80	39.80
PLB 170004	42.60	21.30	*	21.30	*	*	*	*	42.60	42.60	42.60	42.60
PLB 170005	41.60	20.80	*	20.80	*	*	*	*	41.60	41.60	41.60	41.60
PLB 220003	52.80	26.40	*	26.40	*	*	*	*	52.80	52.80	52.80	52.80
PLB 220004	55.60	27.80	*	27.80	*	*	*	*	55.60	55.60	55.60	55.60
PLB 220005	54.60	27.30	*	27.30	*	*	*	*	54.60	54.60	54.60	54.60
PLB 250004	59.20	29.60	*	29.60	*	*	*	*	59.20	59.20	59.20	59.20
PLB 250005	59.00	29.50	*	29.50	*	*	*	*	59.00	59.00	59.00	59.00
PLB 300004	101.80	50.90	*	50.90	*	*	*	*	101.80	101.80	101.80	101.80
PLB 300005	101.40	50.70	*	50.70	*	*	*	*	101.40	101.40	101.40	101.40
PLB 380005	108.60	54.30	*	54.30	*	*	*	*	108.60	108.60	108.60	108.60
PLB 460005	113.60	56.80	*	56.80	*	*	*	*	113.60	113.60	113.60	113.60
PLB 550005	173.60	86.80	*	86.80	*	*	*	*	173.60	173.60	173.60	173.60
PLB 620005	167.60	83.80	*	83.80	*	*	*	*	167.60	167.60	167.60	167.60

NOTE: For the additional oil table see page 45. * Please contact PGR!



Table 15: Lubricant Fill Quantities (PLB - FS)

FS	B51	B55	B53	B54	V15	V16	V17	V18	V35	V36	V37	V38
PLB 1002	1.90	1.20	1.40	1.20	1.60	1.60	1.60	1.60	1.90	1.90	1.90	1.90
PLB 1003	2.20	1.40	1.60	1.40	1.90	1.90	1.90	1.90	2.20	2.20	2.20	2.20
PLB 1004	2.70	1.70	1.90	1.70	2.40	2.40	2.40	2.40	2.70	2.70	2.70	2.70
PLB 1602	2.00	1.20	1.40	1.20	1.70	1.70	1.70	1.70	2.00	2.00	2.00	2.00
PLB 1603	2.30	1.40	1.60	1.40	2.00	2.00	2.00	2.00	2.30	2.30	2.30	2.30
PLB 1604	2.80	1.70	1.90	1.70	2.50	2.50	2.50	2.50	2.80	2.80	2.80	2.80
PLB 2502	2.90	1.80	2.00	1.80	2.60	2.60	2.60	2.60	2.90	2.90	2.90	2.90
PLB 2503	3.30	2.20	2.40	2.20	3.00	3.00	3.00	3.00	3.30	3.30	3.30	3.30
PLB 2504	3.80	2.30	2.50	2.30	3.50	3.50	3.50	3.50	3.80	3.80	3.80	3.80
PLB 5002	5.20	2.90	3.30	2.90	3.70	3.70	3.70	3.70	5.20	5.20	5.20	5.20
PLB 5003	3.30	2.10	2.30	2.10	3.00	3.00	3.00	3.00	3.30	3.30	3.30	3.30
PLB 5004	3.70	2.30	2.50	2.30	3.40	3.40	3.40	3.40	3.70	3.70	3.70	3.70
PLB 7002	6.80	3.80	4.20	3.80	5.30	5.30	5.30	5.30	6.80	6.80	6.80	6.80
PLB 7003	5.40	3.10	3.30	3.10	5.10	5.10	5.10	5.10	5.40	5.40	5.40	5.40
PLB 7004	5.80	3.40	3.60	3.40	5.50	5.50	5.50	5.50	5.80	5.80	5.80	5.80
PLB 10002	8.60	4.70	5.10	4.70	7.10	7.10	7.10	7.10	8.60	8.60	8.60	8.60
PLB 10003	9.20	5.00	5.40	5.00	7.70	7.70	7.70	7.70	9.20	9.20	9.20	9.20
PLB 10004	7.50	4.20	4.40	4.20	7.20	7.20	7.20	7.20	7.50	7.50	7.50	7.50
PLB 16002	9.10	4.90	5.30	4.90	7.60	7.60	7.60	7.60	9.10	9.10	9.10	9.10
PLB 16003	9.60	5.20	5.60	5.20	8.10	8.10	8.10	8.10	9.60	9.60	9.60	9.60
PLB 16004	7.80	4.50	4.70	4.50	7.50	7.50	7.50	7.50	7.80	7.80	7.80	7.80
PLB 18002	15.60	8.60	9.00	8.60	13.30	13.30	13.30	13.30	15.60	15.60	15.60	15.60
PLB 18003	10.60	5.80	6.20	5.80	9.10	9.10	9.10	9.10	10.60	10.60	10.60	10.60
PLB 18004	11.50	6.20	6.60	6.20	10.00	10.00	10.00	10.00	11.50	11.50	11.50	11.50
PLB 25002	14.70	8.00	8.20	8.00	11.80	11.80	11.80	11.80	14.70	14.70	14.70	14.70
PLB 25003	11.70	6.40	6.80	6.40	10.20	10.20	10.20	10.20	11.70	11.70	11.70	11.70
PLB 25004	12.50	6.80	7.20	6.80	11.00	11.00	11.00	11.00	12.50	12.50	12.50	12.50
PLB 30003	19.90	11.00	11.20	11.00	17.60	17.60	17.60	17.60	19.90	19.90	19.90	19.90
PLB 30004	13.90	7.40	7.80	7.40	12.40	12.40	12.40	12.40	13.90	13.90	13.90	13.90
PLB 35002	14.00	7.70	7.90	7.70	11.10	11.10	11.10	11.10	14.00	14.00	14.00	14.00
PLB 35003	19.30	10.50	10.90	10.50	17.00	17.00	17.00	17.00	19.30	19.30	19.30	19.30
PLB 35004	13.40	7.40	7.80	7.40	11.90	11.90	11.90	11.90	13.40	13.40	13.40	13.40
PLB 50002	24.80	13.40	13.60	13.40	22.40	22.40	22.40	22.40	24.80	24.80	24.80	24.80
PLB 50003	18.70	10.00	10.40	10.00	17.20	17.20	17.20	17.20	18.70	18.70	18.70	18.70
PLB 50004	19.40	10.40	10.70	10.40	17.90	17.90	17.90	17.90	19.40	19.40	19.40	19.40
PLB 65003	27.90	14.90	15.10	14.90	25.00	25.00	25.00	25.00	27.90	27.90	27.90	27.90
PLB 65004	25.30	13.50	13.90	13.50	23.80	23.80	23.80	23.80	25.30	25.30	25.30	25.30
PLB 90003	35.00	18.30	18.50	18.30	32.10	32.10	32.10	32.10	35.00	35.00	35.00	35.00
PLB 90004	32.30	17.80	18.20	17.80	30.80	30.80	30.80	30.80	32.30	32.30	32.30	32.30
PLB 130003	37.40	18.70	*	18.70	*	*	*	*	37.40	37.40	37.40	37.40
PLB 130004	39.80	19.90	*	19.90	*	*	*	*	39.80	39.80	39.80	39.80
PLB 130005	38.80	19.40	*	19.40	*	*	*	*	38.80	38.80	38.80	38.80
PLB 170003	39.80	19.90	*	19.90	*	*	*	*	39.80	39.80	39.80	39.80
PLB 170004	42.60	21.30	*	21.30	*	*	*	*	42.60	42.60	42.60	42.60
PLB 170005	41.60	20.80	*	20.80	*	*	*	*	41.60	41.60	41.60	41.60
PLB 220003	52.80	26.40	*	26.40	*	*	*	*	52.80	52.80	52.80	52.80
PLB 220004	55.60	27.80	*	27.80	*	*	*	*	55.60	55.60	55.60	55.60
PLB 220005	54.60	27.30	*	27.30	*	*	*	*	54.60	54.60	54.60	54.60
PLB 250004	59.20	29.60	*	29.60	*	*	*	*	59.20	59.20	59.20	59.20
PLB 250005	59.00	29.50	*	29.50	*	*	*	*	59.00	59.00	59.00	59.00
PLB 300004	101.80	50.90	*	50.90	*	*	*	*	101.80	101.80	101.80	101.80
PLB 300005	101.40	50.70	*	50.70	*	*	*	*	101.40	101.40	101.40	101.40
PLB 380005	108.60	54.30	*	54.30	*	*	*	*	108.60	108.60	108.60	108.60
PLB 460005	113.60	56.80	*	56.80	*	*	*	*	113.60	113.60	113.60	113.60
PLB 550005	173.60	86.80	*	86.80	*	*	*	*	173.60	173.60	173.60	173.60
PLB 620005	167.60	83.80	*	83.80	*	*	*	*	167.60	167.60	167.60	167.60



Table 16: Lubricant Fill Quantities (PLB - CPC)

CPC	B56	B60	B58	B62	B57	B61	B59	B63	V53	V52	V54	V55
PLB 1002	2.80	2.00	2.20	2.00	2.80	1.30	1.50	1.30	2.50	2.50	2.50	2.50
PLB 1003	3.10	2.20	2.40	2.20	3.10	1.50	1.70	1.50	2.80	2.80	2.80	2.80
PLB 1004	3.60	2.50	2.70	2.50	3.60	1.70	1.90	1.70	3.30	3.30	3.30	3.30
PLB 1602	2.80	2.00	2.20	2.00	2.80	1.40	1.60	1.40	2.50	2.50	2.50	2.50
PLB 1603	3.20	2.20	2.40	2.20	3.20	1.60	1.80	1.60	2.90	2.90	2.90	2.90
PLB 1604	3.70	2.50	2.70	2.50	3.70	1.80	2.00	1.80	3.40	3.40	3.40	3.40
PLB 2502	5.80	4.60	4.80	4.60	5.80	2.30	2.50	2.30	5.50	5.50	5.50	5.50
PLB 2503	6.50	4.70	4.90	4.70	6.50	2.60	2.80	2.60	6.20	6.20	6.20	6.20
PLB 2504	6.80	4.80	5.00	4.80	6.80	2.80	3.00	2.80	6.50	6.50	6.50	6.50
PLB 5002	7.60	5.10	5.50	5.10	7.60	3.10	3.50	3.10	6.10	6.10	6.10	6.10
PLB 5003	6.10	4.50	4.70	4.50	6.10	2.40	2.60	2.40	5.80	5.80	5.80	5.80
PLB 5004	6.50	4.70	4.90	4.70	6.50	2.70	2.90	2.70	6.20	6.20	6.20	6.20
PLB 7002	12.70	9.00	9.40	9.00	12.70	5.60	4.50	5.60	11.20	11.20	11.20	11.20
PLB 7003	11.30	8.30	8.50	8.30	11.30	3.70	3.90	3.70	11.00	11.00	11.00	11.00
PLB 7004	12.00	8.70	8.90	8.70	12.00	4.10	4.30	4.10	11.70	11.70	11.70	11.70
PLB 10002	15.10	10.80	11.20	10.80	15.10	5.00	5.40	5.00	13.60	13.60	13.60	13.60
PLB 10003	16.20	11.40	11.80	11.40	16.20	5.60	6.00	5.60	14.70	14.70	14.70	14.70
PLB 10004	14.80	10.70	10.90	10.70	14.80	4.90	5.10	4.90	14.50	14.50	14.50	14.50
PLB 16002	15.30	10.90	11.30	10.90	15.30	5.10	5.50	5.10	13.80	13.80	13.80	13.80
PLB 16003	16.50	11.50	11.90	11.50	16.50	5.80	6.20	5.80	15.00	15.00	15.00	15.00
PLB 16004	15.00	10.90	11.10	10.90	15.00	5.10	5.30	5.10	14.70	14.70	14.70	14.70
PLB 18002	22.70	15.30	15.70	15.30	22.70	9.30	9.70	9.30	20.40	20.40	20.40	20.40
PLB 18003	16.90	11.90	12.30	11.90	16.90	5.90	6.30	5.90	15.40	15.40	15.40	15.40
PLB 18004	18.70	12.80	13.20	12.80	18.70	6.80	7.20	6.80	17.20	17.20	17.20	17.20
PLB 25002	18.50	10.00	10.20	10.00	18.50	10.00	10.20	10.00	15.60	15.60	15.60	15.60
PLB 25003	15.50	8.30	8.70	8.30	15.50	8.30	8.70	8.30	14.00	14.00	14.00	14.00
PLB 25004	15.50	8.80	9.20	8.80	15.50	8.80	9.20	8.80	14.00	14.00	14.00	14.00
PLB 30003	23.70	12.60	12.80	12.60	23.70	12.60	12.80	12.60	21.40	21.40	21.40	21.40
PLB 30004	17.70	9.50	9.90	9.50	17.70	9.50	9.90	9.50	16.20	16.20	16.20	16.20
PLB 35002	17.70	9.70	9.90	9.70	17.70	9.70	9.90	9.70	14.80	14.80	14.80	14.80
PLB 35003	23.40	12.70	13.10	12.70	23.40	12.70	13.10	12.70	21.10	21.10	21.10	21.10
PLB 35004	17.30	9.40	9.80	9.40	17.30	9.40	9.80	9.40	15.80	15.80	15.80	15.80
PLB 50002	28.30	15.40	15.60	15.40	28.30	15.40	15.60	15.40	25.90	25.90	25.90	25.90
PLB 50003	22.10	11.90	12.30	11.90	22.10	11.90	12.30	11.90	20.60	20.60	20.60	20.60
PLB 50004	22.00	13.30	13.70	13.30	22.00	13.30	13.70	13.30	20.50	20.50	20.50	20.50
PLB 65003	30.20	16.10	16.30	16.10	30.20	16.10	16.30	16.10	27.30	27.30	27.30	27.30
PLB 65004	27.20	14.80	15.20	14.80	27.20	14.80	15.20	14.80	25.70	25.70	25.70	25.70
PLB 90003	44.5	22.3	22.5	22.3	41.6	41.6	41.6	41.6	44.5	44.5	44.5	44.5
PLB 90004	40.3	21.8	22.2	21.8	38.8	38.8	38.8	38.8	40.3	40.3	40.3	40.3

NOTE: For the additional oil table see page 45.



Table 17: Lubricant Fill Quantities (PLB - CPC)

CPC	V49	V48	V50	V51	V42	V40	V41	V43	V46	V44	V45	V47
PLB 1002	2.50	2.50	2.50	2.50	2.80	2.80	2.80	2.80	2.80	2.80	2.80	2.80
PLB 1003	2.80	2.80	2.80	2.80	3.10	3.10	3.10	3.10	3.10	3.10	3.10	3.10
PLB 1004	3.30	3.30	3.30	3.30	3.60	3.60	3.60	3.60	3.60	3.60	3.60	3.60
PLB 1602	2.50	2.50	2.50	2.50	2.80	2.80	2.80	2.80	2.80	2.80	2.80	2.80
PLB 1603	2.90	2.90	2.90	2.90	3.20	3.20	3.20	3.20	3.20	3.20	3.20	3.20
PLB 1604	3.40	3.40	3.40	3.40	3.70	3.70	3.70	3.70	3.70	3.70	3.70	3.70
PLB 2502	5.50	5.50	5.50	5.50	5.80	5.80	5.80	5.80	5.80	5.80	5.80	5.80
PLB 2503	6.20	6.20	6.20	6.20	6.50	6.50	6.50	6.50	6.50	6.50	6.50	6.50
PLB 2504	6.50	6.50	6.50	6.50	6.80	6.80	6.80	6.80	6.80	6.80	6.80	6.80
PLB 5002	6.10	6.10	6.10	6.10	7.60	7.60	7.60	7.60	7.60	7.60	7.60	7.60
PLB 5003	5.80	5.80	5.80	5.80	6.10	6.10	6.10	6.10	6.10	6.10	6.10	6.10
PLB 5004	6.20	6.20	6.20	6.20	6.50	6.50	6.50	6.50	6.50	6.50	6.50	6.50
PLB 7002	11.20	11.20	11.20	11.20	12.70	12.70	12.70	12.70	12.70	12.70	12.70	12.70
PLB 7003	11.00	11.00	11.00	11.00	11.30	11.30	11.30	11.30	11.30	11.30	11.30	11.30
PLB 7004	11.70	11.70	11.70	11.70	12.00	12.00	12.00	12.00	12.00	12.00	12.00	12.00
PLB 10002	13.60	13.60	13.60	13.60	15.10	15.10	15.10	15.10	15.10	15.10	15.10	15.10
PLB 10003	14.70	14.70	14.70	14.70	16.20	16.20	16.20	16.20	16.20	16.20	16.20	16.20
PLB 10004	14.50	14.50	14.50	14.50	14.80	14.80	14.80	14.80	14.80	14.80	14.80	14.80
PLB 16002	13.80	13.80	13.80	13.80	15.30	15.30	15.30	15.30	15.30	15.30	15.30	15.30
PLB 16003	15.00	15.00	15.00	15.00	16.50	16.50	16.50	16.50	16.50	16.50	16.50	16.50
PLB 16004	14.70	14.70	14.70	14.70	15.00	15.00	15.00	15.00	15.00	15.00	15.00	15.00
PLB 18002	20.40	20.40	20.40	20.40	22.70	22.70	22.70	22.70	22.70	22.70	22.70	22.70
PLB 18003	15.40	15.40	15.40	15.40	16.90	16.90	16.90	16.90	16.90	16.90	16.90	16.90
PLB 18004	17.20	17.20	17.20	17.20	18.70	18.70	18.70	18.70	18.70	18.70	18.70	18.70
PLB 25002	15.60	15.60	15.60	15.60	18.50	18.50	18.50	18.50	18.50	18.50	18.50	18.50
PLB 25003	14.00	14.00	14.00	14.00	15.50	15.50	15.50	15.50	15.50	15.50	15.50	15.50
PLB 25004	14.00	14.00	14.00	14.00	15.50	15.50	15.50	15.50	15.50	15.50	15.50	15.50
PLB 30003	21.40	21.40	21.40	21.40	23.70	23.70	23.70	23.70	23.70	23.70	23.70	23.70
PLB 30004	16.20	16.20	16.20	16.20	17.70	17.70	17.70	17.70	17.70	17.70	17.70	17.70
PLB 35002	14.80	14.80	14.80	14.80	17.70	17.70	17.70	17.70	17.70	17.70	17.70	17.70
PLB 35003	21.10	21.10	21.10	21.10	23.40	23.40	23.40	23.40	23.40	23.40	23.40	23.40
PLB 35004	15.80	15.80	15.80	15.80	17.30	17.30	17.30	17.30	17.30	17.30	17.30	17.30
PLB 50002	25.90	25.90	25.90	25.90	28.30	28.30	28.30	28.30	28.30	28.30	28.30	28.30
PLB 50003	20.60	20.60	20.60	20.60	22.10	22.10	22.10	22.10	22.10	22.10	22.10	22.10
PLB 50004	20.50	20.50	20.50	20.50	22.00	22.00	22.00	22.00	22.00	22.00	22.00	22.00
PLB 65003	27.30	27.30	27.30	27.30	30.20	30.20	30.20	30.20	30.20	30.20	30.20	30.20
PLB 65004	25.70	25.70	25.70	25.70	27.20	27.20	27.20	27.20	27.20	27.20	27.20	27.20
PLB 90003	44.5	44.5	44.5	44.5	-	-	-	-	-	-	-	-
PLB 90004	40.3	40.3	40.3	40.3	-	-	-	-	-	-	-	-

NOTE: For the additional oil table see page 45.





6.3 Lubrication Table

Table 18: Lubrication Table

LUBRICATION									
Ambient Temperature	Mineral Oil			Poly - Alpha - Olefin Synthetic Oils (PAO)			Polyglycol Synthetic Oils (PG)		
	-10 °C +30 °C	+10 °C +45 °C	+30 °C +60 °C	-20 °C / +60 °C			-20 °C / +60 °C		
MANUFACTURER	ISO VG 150	ISO VG 220	ISO VG 320	ISO VG 150	ISO VG 220	ISO VG 320	ISO VG 150	ISO VG 220	ISO VG 320
AGIP	Blasia 150	Blasia 220	Blasia 320	-	Blasia SX 220	Blasia SX 320	Blasia S 150	Blasia S 220	Blasia S 320
BP	Energol GR-XP 150	Energol GR-XP 220	Energol GR-XP 320	Enersyn EPX 150	Enersyn EPX 220	Enersyn EPX 320	Enesyn SG 150	Enesyn SG 220	Enesyn SG 320
CASTROL	Alpha SP 150	Alpha SP 220	Alpha SP 320	Alphasyn EP 150	Alphasyn EP 220	Alphasyn EP 320	Alphasyn PG 150	Alphasyn PG 220	Alphasyn PG 320
CHEVRON	Ultra Gear 150	Ultra Gear 220	Ultra Gear 320	Tegra Synt. 150	Tegra Synt. 220	Tegra Synt. 320	HiPerSYN 150	HiPerSYN 220	HiPerSYN 320
ESSO	Spartan EP 150	Spartan EP 220	Spartan EP 320	Spartan S EP 150	Spartan S EP 220	Spartan S EP 320	Glycolube 150	Glycolube 220	Glycolube 320
KLUBER	Klüberoil GEM 1-150	Klüberoil GEM 1-220	Klüberoil GEM 1-320	Klübersynth EG 4-150	Klübersynth EG 4-220	Klübersynth EG 4-320	Klübersynth GH 6-150	Klübersynth GH 6-220	Klübersynth GH 6-320
MOBIL	Mobilgear XMP 150	Mobilgear XMP 220	Mobilgear XMP 320	Mobilgear SCH XMP 150	Mobilgear SCH XMP 220	Mobilgear SCH XMP 320	Glygoyle 22	Glygoyle 30	Glygoyle 22
SHELL	Omala 150	Omala 220	Omala 320	Omala HD 150	Omala HD 220	Omala HD 320	Tivela S150	Tivela S220	Tivela S320
TOTAL	Carter EP 150	Carter EP 220	Carter EP 320	Carter SH 150	Carter SH 220	Carter SH 320	Carter SY 150	Carter SY 220	Carter SY 320

It is forbidden to use different kind of oil without the approval of the PGR technical service

 	EXPLOSION !
<p>In gearboxes which will be operated at explosive atmosphere, synthetic lubricant should be used.</p>	



6.4 Expansion Tank

At the vertical mountages, using expansion tank at higher than the peak point of the gear unit is recommended by PGR.

It's duty is to retain oil expansion and providing to make the oil support to unreachable points.

This appurtenance is sent separately from the gear unit upon request.

Figure 11: Expansion Tank

- ▼ Filling Plug
- ▽ Vent Plug
- ⊖ Oil Level Plug

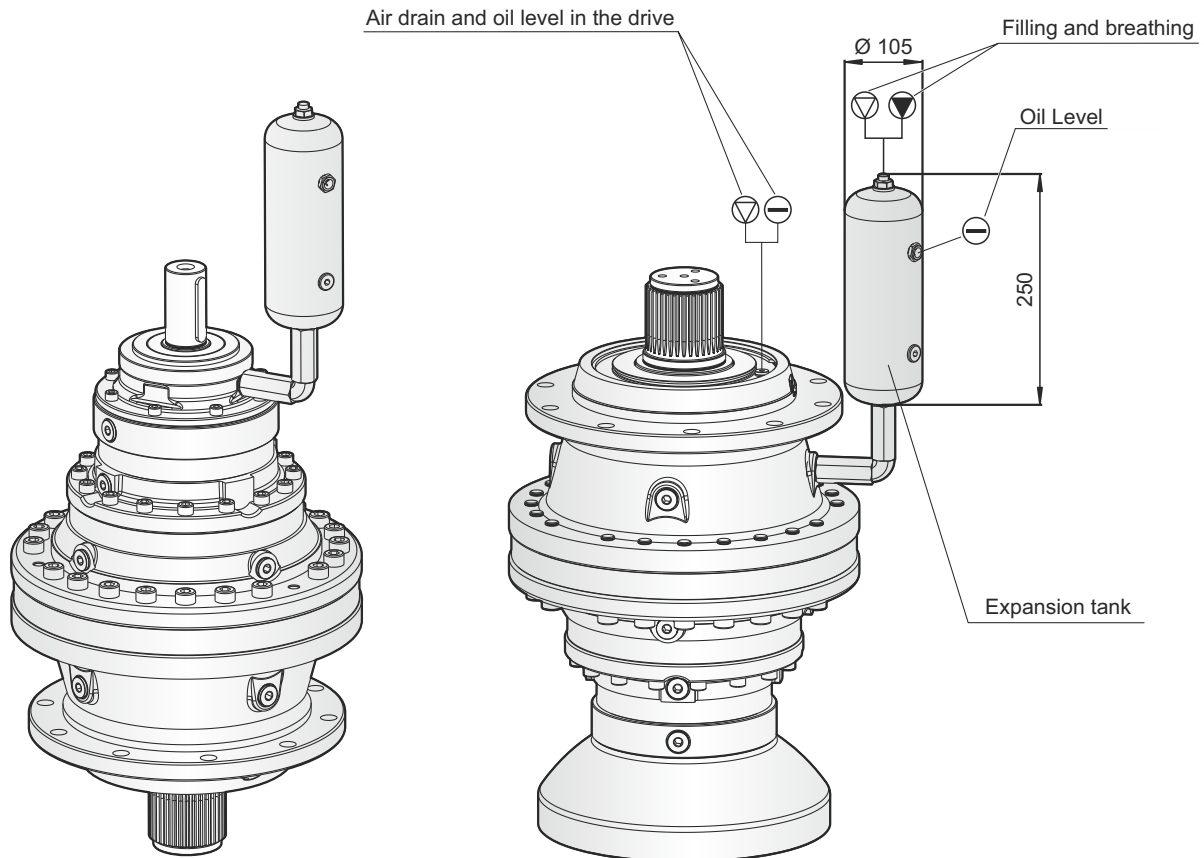



7.1 Shrink Disc

Figure 12: Shrink Disc

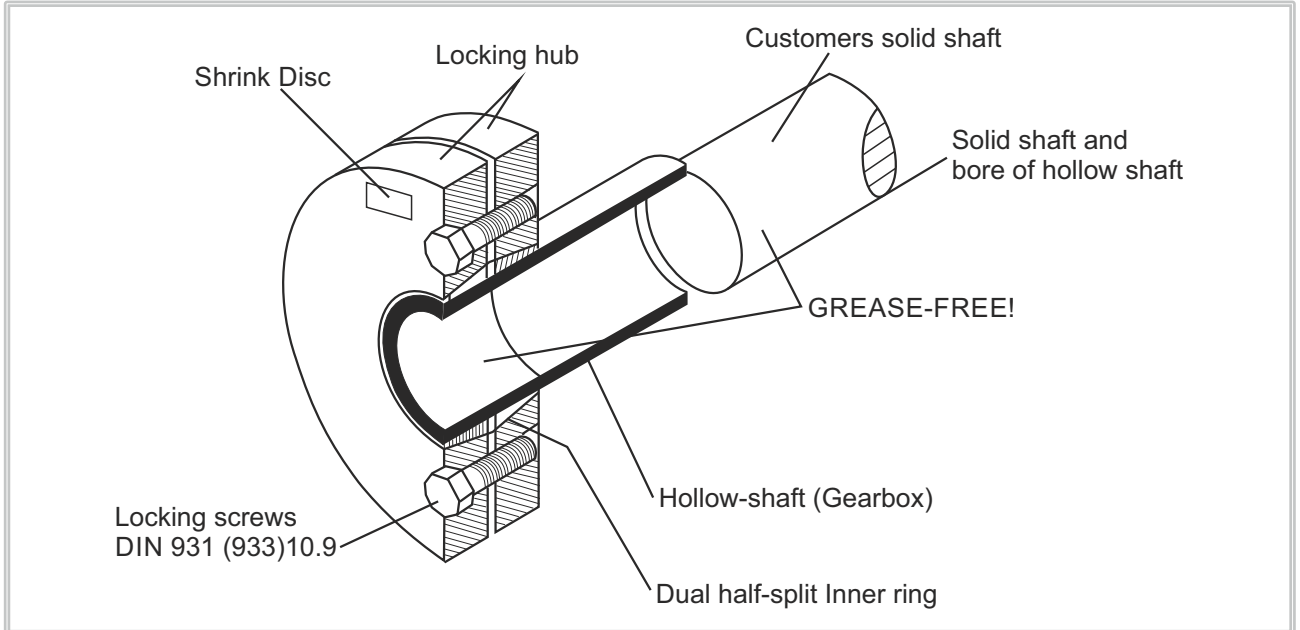

	<p>NOTE !</p> <p>Shrink disc would be sent ready to assembly by manufacturer. Please do not segment the shrink disc into pieces before assembly process. There could be wounding risk during both assembly and disassembly. Please obey instructions given below.</p>
	<p>NOTE !</p> <p>Do not tighten screws on the shrink disc without installing the shaft. If it is tightened, hollow shaft could be damaged.</p>

7.1.1 Mounting Position of the Shrink Disc;

- If there is, the shrink disc must be removed from the package.
- The clamping bolts are loosened but must not be removed. Must be squeezed with the help of hand until to get the space out of between the flanges and inner loop.
- The external clamping flange connected to the gear unit's shaft, shrink disc must be pushed on to the output shaft. Soft grease must applied to the hole at inner ring. (for easing the pushing process).
- The soft grease must be applied to the spacer side of customer applications solid shaft. The oil must not be touched the compressed side of the shrink disc. For not creating that kind of risk, the grease should not be applied directly on the spacer.
- The grease both on the gear unit's shaft and customer's application shaft must be fully cleaned and be ungreased.
- The Customer's applications solid shaft must be mounted completely to the hollow shaft to the shrink disc's shrinking area.
- To positioned the shrink disc, the clamping bolts must slightly tightened.
- The clamping bolts must be tightened at clockwise a few times respectively (approximately ¼ bolt tour per tour). Never be tightened diagonally.
- After tightened the clamping bolts, there should be an equal space between the clamping bolts. If this space is not ensured, the gear unit must be dismantled and the sensibility of the external tightened flange of the shrink disc must be controlled.



7.1.2 Demounting Position of the Shrink Disc;

- The clamping bolts must be loosened respectively a few times. (approximately ¼ bolt tour per tour) But clamping bolts must not be fully removed.
- The shrink disc should not be separated from the gear unit's shaft.
- The gear unit must be removed from customer's applications solid shaft.

	DANGER !
	If the shrink disc are mounted and dismantled incorrectly, the wounding danger could exist.

7.1.3 Cleaning of the Shrink Disc;

- Dismantled shrink disc before remounting, is not needed to subject the cracking process.
- Only the polluted surfaces of the shrink disc must be cleaned.
- The conical surfaces must be lubricated with one of the the solid material lubricants listed below.

Table 19: Lubrication Schedule While Cleaning of Shrink Disc

Lubricant (Mo S2)	Type
<ul style="list-style-type: none"> ▶ Molykote 321 (Slippery lac) ▶ Molykote Spray (Powder spray) ▶ Molykote G Rapid ▶ Aemasol MO 19P ▶ Aemasol DIO-setral 57 N (Slippery lac) 	<ul style="list-style-type: none"> ▪ Spray ▪ Spray ▪ Spray or paste ▪ Spray or paste ▪ Spray

For the lubricating of clamping screws Molykote BR 2 or similar material must be used.

7.2 Torque Arm

Figure 13: Torque Arm

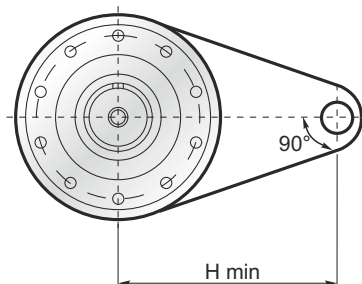

Catalog : PL/PLB
Page : 314 - 702

The torc arms in the FS type exits are the appurtenances used together with the shrink disc. If these torc arms are single supported, it is significant to take care of the Hmin value and 90° angle specified in the catalogue. Before to fasten the torc arm clean the moutage and hole faces and refine from the oil.



7.3 Backstop

Backstop prevents output shaft from rotation in the wrong direction. Depending on the type and size of the gearbox, the backstop can be installed to the case, input flange or motor. It is important to specify the required output rotation direction.

	<p>NOTE !</p> <ul style="list-style-type: none"> - The action of the motor in locking direction could cause fracturing of the lock. - The motor absolutely must not rotated to the direction of locking. To provide specified direction of rotation, it must be careful that the motor is supplied by direct current. - As a control, the output shaft/hollow shaft of the gearbox should be turned half a turn against the backstop direction.
---	---

The allowed direction of rotation is marked on the gear unit.
If the backstop direction is wrong, please contact PGR.

7.4 Input Accessories

PGR Industries reduction gears can be supplied with different input options.
By means of the input flanges with and without brake, the following accessories can be mounted:

Figure 14: Input Accessories

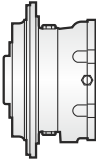
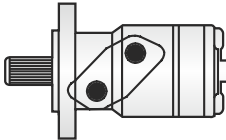
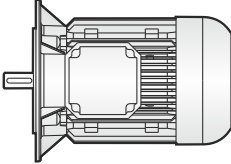
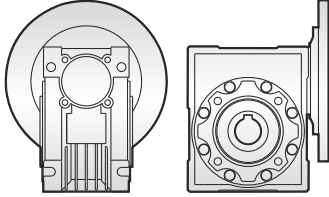
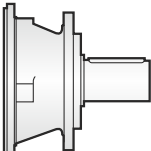
- Negative Modular Brakes 
- Hydraulic Motors 
- Electric Motors 
- Worm Gears 
- Input Shafts 



8.1 Product Disposal

Dismantle the machine, separating the parts following the instructions given in this manual. You must group the parts according to the materials they are made of: iron, aluminium, copper, plastic and rubber.

The parts must be disposed of by the relative centres in full compliance with the laws and force on the matter of dismantling and demolishing industrial waste.

Waste Oil: At the disposal of waste oil, please obey both to the environmental protection laws as well as rules and regulations those are in force into countries which the machine has been using of.

8.1.1 Disposal

The valid regulations must be taken into the consideration for the waste materials.

Table 20: Disposal Table

GEAR UNIT COMPONENTS	MATERIAL
Toothed wheels, shafts, rolling bearings, parallel keys, locking rings,...	Steel
Gear unit housing, housing components,...	Grey cast iron
Light alloy gear unit housing, light alloy gear unit housing components,...	Aluminium
Worm gears, bushes,...	Bronz
Radial seals, sealing caps, rubber components,...	Elastomers with steel
Coupling components	Plastic with steel
Flat seals	Asbestos - free sealing material
Gear oil	Additive mineral oil
Synthetic gear oil (rating plate code: CLP PG)	Polyglycol - based lubricants
Cooling spiral, embedding material of the cooling spiral, screw fittings	Copper, epoxy, yellow brass

	NOTE !
	Please do not diffuse any biologically indivisible materials, oil and noninclusive components (PVC,rubber,resins and etc.) to the environment.

	ATTENTION !
	Do not reuse damaged parts during inspection, only should be changed by expert personnels.



8.2 Troubleshooting

Table 21: Troubleshooting

NO	PROBLEM	OBSERVED	SOLUTION
1	Gearbox does not work.	The noise is not coming from gearbox. Output shaft of the gearbox is not rotating. Driver / frequency inverter is not be used.	Check the connection of electric motor, voltage and frequency. The values could be same with the values which are on the motor label. Look at to the motor usage guide. If the solution is not found look to the article 50.
2	Gearbox does not work.	The noise is not coming from gearbox. Output shaft of the gearbox is not rotating. Driver / frequency inverter is used.	Look to the guide of driver / frequency inverter or driver usage guide. Determine that error is not originated from driver / frequency inverter by seperating electric motor either from driver and frequency inverter and making direct connection to the motor.
3	Gearbox does not work.	A different noise is coming out of the gearbox. But gearbox and motor shaft are not rotating. Driver / frequency inverter or magnetic brake are not used.	The first thing that has to be made is to check whether motor connection, voltage and frequency are identical with motor label values. If there is not any problem, to pull out gearbox from the machine and try to operate in neutral. If gearbox works, the power of motor may not be enough to operate system. If the motor which connected to the gearbox is monophas, take off capacitors should be controlled. Even the motor does not work despite all tests and examinations, look at to the article 50.
4	Gearbox does not work.	A different noise is coming out of the gearbox. But gearbox and motor shaft are not rotating. Driver / frequency inverter or magnetic brake are used.	The frequency inverter or driver usage guide should be examined. Determine that error is originated whether from driver / frequency inverter by seperating electric motor either from driver and frequency inverter and making direct connection to the motor. If the gearbox does not work, look at to the article 50.
5	Gearbox does not work.	A different noise is coming out of the gearbox. But gearbox and motor shaft are not rotating. Magnetic brake is used.	It is necessary to check whether electric motor connection, voltage and frequency are identical with motor label values. Look at to the motor usage guide. Be sure that brake is working. If the brake is assembled by us to check whether it is made correctly according to the schema at the usage and maintenance instructions. If the error is not found to check whether the brake is operating by making direct connection to the brake appropriate to the brake voltage. When the electric is given, the noise of the opening of brake will come. If the brake is not working even by giving electric, the diode of brake could be in failure. To feed the motor directly according to the informations on the label when the brake is seperated from disc. If the problem is continuing, the power of the motor may not be enough. Look to the article 50.
6	Gearbox does not work at low speeds / frequencies.	Use driver / frequency inverter.	The motor feeding frequency is declining at low speeds. For the operating of motor at very low frequencies, it is essential to adjust motor parameters and frequency inverter parameters very well. Besides for the low speeds, there could be big changes even at the gearbox efficiency. To enlarge motor power and inverter or for to reach your requested cycle range, change the gearbox ratio.



NO	PROBLEM	OBSERVED	SOLUTION
7	Gearbox does not work after long awaitings or at mornings.	Environmental temperatures are dropping below -5°C.	The gearbox oil is not suitable to the environmental temperatures where it works. It is necessary to use low viscosity oils or to protect gearbox group from cold. To find proper oil look to usage guide or examine lubricating pages from the product catalogs. To work at higher environmental temperatures could be a solution. If the problem is continuing, the motor power should be increased.
8	Gearbox is very heating up.	You use worm screw type gearbox and environmental temperature is under +40°C.	When the gearbox is working under the full load, gauge gearbox surface temperature with heat meter. If it is under +90°C it is normal and no harm to gearbox. All worm screw and ATEX compatible helical gearboxes could be used up to the +120°C surface temperatures. If the temperature is above the +120°C and gearbox is ATEX compatible immediately stop gearbox and inform to PGR. Look to the article 50. If it is the product without ATEX, to check the oil amount according to the mountage position. Be sure that the mounting position written on the label and mounting position which gearbox is working should be identical. If not look to the article 50. To the gearboxes without worm screw types at heatings above +80°C, look to the articles 9 and 50.
9	Gearbox is very heating up.	You use helical gearboxes and environmental temperature is under +40°C.	When the gearbox is working under the full load, gauge gearbox surface temperature with heat meter. If it is under +90°C it is normal and no harm to the gearbox. All gearboxes with ATEX are designed to work at maximum +120°C. If the temperature is above +120°C and gearbox is ATEX compatible immediately stop gearbox and inform to PGR. The gearboxes without ATEX are designed to work at maximum +90°C temperature values. If the gearbox temperature is above the +90°C, control the oil amount according to mounting position. Be sure that the mounting position written on the label and mounting position which gearbox is working should be identical. If there is inconsistency look to the article 50.
10	Gearbox is very heating up.	Environmental temperature is above +40°C.	The standard gearboxes are designed to work at maximum +40°C. Temperatures above +40°C, special applications and additions should be done. In these situations please consult to PGR.
11	Gearbox is working noisy.	Noise is regular and perpetual.	Control the mobile machine elements. Operate gearbox without load by separating from the system. If you hear the same noise, bearings which belong to gearbox or motor could be in failure. Look to the article 50.
12	Gearbox is working noisy.	Noise is irregular.	Control the mobile machine elements. Operate gearbox without load by separating from the system. If the same noise is continuing, foreign objects could be in the oil. Change the oil and control the foreign objects in the oil. If the metal piece is found into the controlled oil, the gearbox could be damaged. Look to the article 50.



NO	PROBLEM	OBSERVED	SOLUTION
13	Gearbox is working noisy.	Noise is regular with clicking.	Control the mobile machine elements. Operate gearbox without load by seperating from the system. If the same noise is continuing, gearbox parts could be damaged. Look to the article 50.
14	Gearbox is working noisy.	Noise is regular and fluctuating.	Control the flexure of connection elements which connect to output shaft. Seperate element which is connected to output shaft and operate gearbox without load. If the same noise is continuing, look to the article 50.
15	Gearbox is working noisy.	Gearbox has motor with brake and noise is coming from the brake side.	The noises could be coming from the brake like in the shape of low level randomly tickings and it is normal. If the noise level is disturbing, brake could be damaged or there may be a problem at the gap adjustment between lining and disc. Look to the article 50.
16	Gearbox is working noisy.	You use frequency invertor and the noise is changing every time by the change of cycle.	Frequency invertor parameters may not be compatible with your used motor. Examine frequency invertor usage guide and if the same problem is continuing look to the article 50.
17	Oil leakage is existing.	Oil leakage from the seal.	If the environmental temperature is above +40°C and there is continious working over 16 hours, according to the mounting position pull out a plug which is on the top and use ventilation plug instead of it. If your situation is not suited to this, seal could be damaged. Look to the article 50.
18	Oil leakage is existing.	Oil is leaking from the plug.	If you use the ventilation plug, be sure that the plug is at the right position. According to the mounting position of the gearbox, plug which is on the top could be ventilation plug. The plug may loosened, clean the surface and plug itself and squeeze it again. If the same problem is continuing, look to the article 50.
19	Oil leakage is existing.	Oil is coming out of the the housing.	To observe where the oil is exactly coming from. It is leaking from the oil plug, oil cover or seal and could flow onto the housing. If the situation is like this, look to the article 18 and 19. If you sure that oil is coming out of the housing there could be cracks and fractures at the housing. Look to the article 50.
20	Oil leakage is existing.	Oil is coming out of the the cover.	A gasket that is used between cover and housing is not performing its leaktightness duty. Dismantle the cover clean the bottom side and assemble cover to its place by smearing liquid gasket. If the problem continues look to the article 50.
21	Gearbox is making regular vibrations when it is worked at the assemble point.	You use torc arm.	The reason of the vibration of gearbox is originated from the shaft flexure which gearbox is connected. When the torc arm is used, it has no harm to gearbox and it is usual situation.



NO	PROBLEM	OBSERVED	SOLUTION
22	Gearbox is making random vibrations when it is worked at the assemble point.	You use torc arm.	The reason of the vibration of gearbox is because of shaft flexure which the gearbox is connected and passing gap between shaft and bushing. Control your shaft hole passing tolerance. When the torc arm is used, it has no harm to gearbox and it is usual situation.
23	Motor is warming a lot.	Motor is working above its normal ampere. Environment is clear.	There could be overloading or motor power is insufficient. Motor could be in failure. Look to the article 50.
24	Motor is warming a lot.	Environment is dusty.	Be sure of whether motor fan bowl and motor cooler cores are clean for the air passing. If you use extra fan be sure that it is working. If there is invertor usage at the motor and works at low frequencies, the motor fan may not be sufficient. Use extra fan in these situations. If the problem continues look to the article 50.
25	Motor shaft is rotating but gearbox shaft is not.	Friction noise is coming from inside of gearbox or only there is motor noise.	There could be a damage at the gearbox parts. Look to the article 50.
26	Motor shaft is rotating but gearbox shaft is not.	You use chain geared or pinion geared at the output shaft of gearbox.	The damage could be originated of poligon impact formed by chain geared or from the radial load. Gearbox connection points may not be rigid enough. Be sure that you are able to use proper chain geared and pinion geared for used gearbox. Recalculate maximum allowable radial load according to this position. Look to the article 50.
27	Output shaft is cut.	You use either chain geared or pinion geared.	The damage could be originated of poligon impact formed by chain geared or from the radial load. Gearbox connection points may not be rigid enough. Be sure that you are able to use proper chain geared and pinion geared for used gearbox. Recalculate maximum allowable radial load according to this position. Look to the article 50.
28	Gearbox is stopping too late.	You use motor with brake	Control the electric connection schema of brake. Be sure that there is not assembled delayed diode onto the brake. If there is delayed diode, it could be changed. (Hoisting gearboxes are excluded PCS)
50	Service is required.	Informing of PGR Company.	Please contact with PGR company. Communication informations are given at the usage guides,catalogs. Mechanical parts can only be changed either by PGR or within the knowledge. Any change that is to be made without the knowledge of PGR would cancel both guarantee of product and all certificate declerations and remove the responsibilities of PGR over the product.

If there are problems or malfunctions different to the onesdescribed here contact a PGR Industries Assistance Centre.



9.1 Authorized Service

They are skill and qualified people, which are determined by company. They have education about electrical and mechanical subject.

	<p>NOTE !</p> <p>At below; the list took in place decided by our firm, authorized service and customer (user) which is about control and maintenance criterias/applications. Must be obliged to the informations which were given in the list. To the contrary that Usage and Maintenance directions become invalid.</p>
--	---

Table 22: Authorized Service

No	CRITERIA	MANUFACTURER (PGR)	AUTHORIZED SERVICE	CUSTOMER (USER)
1	Disassembly of geared unit	✓	✓	X
1.1	Case changing	✓	✓	X
1.2	Gear changing	✓	✓	X
1.3	Solid / shaft changing	✓	✓	X
1.4	Changing of all consumable material except sealing materials	✓	✓	X
2	Oil cup changing	✓	✓	✓
3	Seal changing	✓	✓	✓
4	Oil changing	✓	✓	✓
5	Motor montage to IEC adapter type	✓	✓	✓
6	Motor montage to PAM type	✓	✓	✓
7	Assembly of geared unit with W cylinder type	✓	✓	✓
8	Disassembly of motor from IEC / PAM type	✓	✓	✓

✓ : SUITABLE

X : NOT SUITABLE

2-3 : Send to the contaminated waste disposal (licensed firm).

4 : Send to the licensed firm for the purpose of disposal.

**10.1 Declaration of Conformity****DECLARATION OF CONFORMITY****COMPANY**

NAME : POLAT GRUP REDÜKTÖR SAN. VE TİC. A.Ş.
ADDRESS: Ata OSB Mah. Astim 1.Cad. No: 4, PK 105 Efeler / Aydın / TURKEY
PHONE : +90 256 231 19 12 - 16 (pbx)
FAX : +90 256 231 19 17

PRODUCT

NAME : PLANET GEAR UNITS
TYPE : PL / PLB
BRAND : PGR

MODEL : PL	1001 ... 620001	PLB	1002 ... 50002
	1002 ... 620002		1003 ... 220003
	1003 ... 620003		1004 ... 300004
	1004 ... 620004		130005 ... 620005
	130005 ... 620005		

APPLIED REGULATIONS:

Machinery Directive	2006/42/EC
ATEX	2014/34/EU
Low Voltage Directive	2014/35/EU

APPLIED HARMONIZED STANDARDS:

TS EN ISO 12100:2010
TS EN ISO 13857
TS EN 60204
TS EN ISO 80079-36:2016
TS EN ISO 80079-37:2016

Our products comply with the regulations and standards described above. When our products are fitted with an electric motor, we fulfill the requirements to the extent that the Low Voltage Regulation is included in the application area 2014/35/EU.



Applied Person
Necdet DEMİR
General Manager

Date: 11 July 2016



10.2 ATEX Document



[1] **CERTIFICATE OF RECEIPT OF TECHNICAL FILE**
ACCORDING TO ATEX 2014/34/EU DIRECTIVE

- [2] According to Article 13.1 b (ii), Directive 2014/34/EU, we confirm the receipt of documentation to retain it.
- [3] Receipt Number: SCA18TDEX006
- [4] Technical File Number: PGRATEX18 / Rev.00
- [5] Date: 22.03.2018
- [6] Equipment or Protective System: GEARBOX - GEAR UNIT
Models: P,PA,PF,PD,PM,PKD,PSH,P+A,PMRV,PMRV Plus,A,F,D,M,K,PL,PLB,PH,PB,PK,PRC/PRCF,PEX,PCS
- [7] Manufacturer: POLAT GROUP REDUKTOR SAN. VE TIC. A.S.
- [8] Address : ATA MAH. ASTIM. OSB 1. CADDE , NO:4 EFELER-AYDIN/TURKEY
- [9] SCA, notified body that no. 2336, in accordance with the Council Directive 2014/34/EU of 26 February 2014, herewith acknowledges receipt, from the Manufacturer, of the technical documents (Technical File).
- [10] This acknowledgement is an evidence about fulfillment of manufacturer duties concerning communicate the dossier of technical documentation to notified body in accordance with clause Article 13.1 b (ii) of Directive 2014/34/EU ATEX. Further requirements of the Directive apply to the manufacturing process and supply of this equipment or protective system.
- [11] SCA holds the Technical File for at least ten years from the date of the last manufactured apparatus. In case of lack of a written acknowledgement from the manufacturer about the intention of maintaining the Technical File deposit, SCA will hold the TECHNICAL FILE in its archives for 10 years, starting from the date this receipt is confirmed.
- [12] This receipt can be reproduced only entirely and with no change.
- [13] Reference standards:
EN ISO 80079-36:2016 , EN ISO 80079-37:2016
- [14] Marking of the equipment or protective system according to manufacturer's declaration :



II 2G Ex h IIC T4 Gb
II 2D Ex h IIC T120°C Db



Digitally
signed by
İSMAIL
OĞLAKCIOĞLU

CONFIRMATION

İsmail OĞLAKCIOĞLU
SCA Technical Manager

Issue Date : 26.03.2018
Translation Date : 20.06.2019

SCA Belgelendirme ve Özel Eğitim Hizmetleri Ltd. Şti.
Mansuroğlu Mah. 284/1 Sok. No:1 İhsaniye Plaza D.17 Bayraklı İZMİR / TURKEY
Phone: 0090- 232 - 489 02 12 Fax: 0090 - 489 02 17
www.scaatex.com e-mail: info@scaatex.com

**11.1 Contact Information****FACTORY**

ATA OSB MAH. ASTİM 1. CAD. NO: 4, PK 105 Efeler / Aydın / TURKEY

Tel : +90 256 231 19 12 - 16 (pbx)
Fax : +90 256 231 19 17
Web : www.pgr.com.tr
e-mail : info@pgr.com.tr - satissonrasi@pgr.com.tr

ASSEMBLY FACTORY AND LOGISTICS CENTER

AYDIN ORGANİZE SANAYİ BÖLGESİ UMURLU MAH. NO:66 Efeler / Aydın / TURKEY

Tel : +90 256 231 19 12 - 16 (pbx)
Fax : +90 256 231 19 17
Web : www.pgr.com.tr
e-mail : info@pgr.com.tr - satissonrasi@pgr.com.tr

AREAS**ANKARA AREA**

AHI EVRAN CAD. 1203.SK NO:18 D:58-60 İSGEM Ostim / Ankara / TURKEY

Tel : +90 312 354 44 08
+90 312 385 86 68
Fax : +90 312 385 79 27
Web : www.pgr.com.tr
e-mail : ankara@pgr.com.tr

ISTANBUL AREA

ŞERİFALİ MAH. ALPTEKİN CAD. SÖYLEŞİ SOK. NO:31 Ümraniye / İstanbul / TURKEY

Web : www.pgr.com.tr
e-mail : istanbul@pgr.com.tr

GERMANY AREA

IN DER SCHLINGE 6, D-59227 Ahlen / GERMANY

Tel : +49 (0) 238 2855 7010
: +49 (0) 238 2855 7011
: +49 (0) 238 2855 7012
: +49 (0) 238 2855 7016
Web : www.pgr.com.tr
e-mail : info@pgrgermany.de

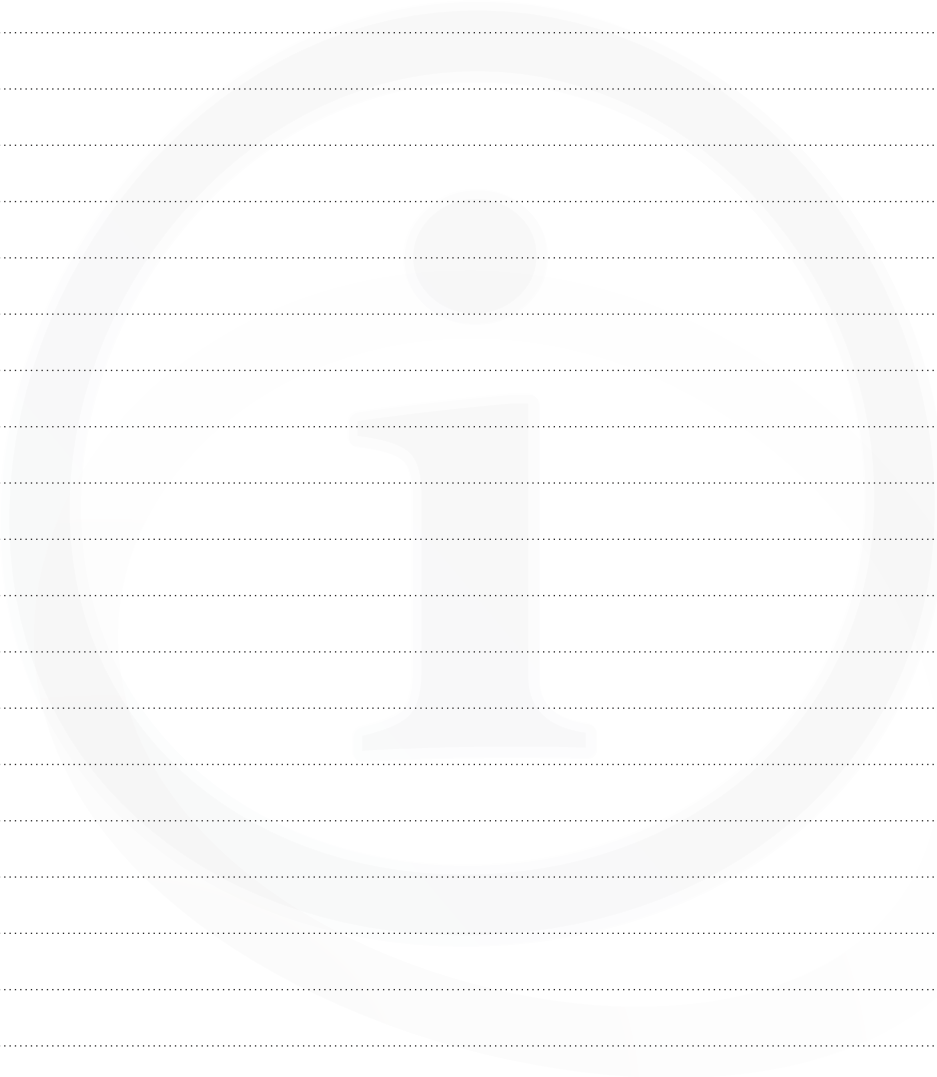



- Ata OSB Mah. Astim 1. Cad. No: 4, Pk 105 Efeler / Aydın / TÜRKİYE
- T: +90 256 231 19 12 - 16 (pbx)
- F: +90 256 231 19 17
- info@pgr.com.tr - satissonrasi@pgr.com.tr
- www.pgr.com.tr